

oben[®]
SINCE 1923
tiled shower solutions

solaire[®]

solaire bases

Level entry | Threshold
Point Drain

Pre-Form Tile Over



OBEN HISTORY

Since 1923 Oben's family founders have been passionate about creating the perfect bathroom a place where water and wonderful ideas flow together in endless expressions of innovation, indulgence and design.

For over 95 years this proud family-owned business has dedicated itself to being first with the future and second-to-none with everything else!

It's an attitude that has made it an undisputed market leader and earned it an envied international reputation as a modern day pioneer of bathroom and showering technology.

Oben's innovative shower products are built with the same solidity, durability and quality as their reputation so that you may enjoy the pleasure of their performance and beauty of their designs for many years to come.



Derek Englefield

Managing Director



Contents

Walk-In Shower	4 - 5
Slide Showers	6 - 7
Rectangular Corner Showers	8 - 9
Square Corner Showers	10 - 11
Alcove Showers	12 - 13
Neo-Angle Showers	14 - 15
Shower Niches/Foot Rest	16 - 17
Glide Glass® Easy Clean	18
Product Finishes	19
Rock-Stone® Base Features & Benefits	20 - 21
Rock-Stone® Base Installation	22 - 23
Shower Niche Technical	24
Oben PVC Drains Technical	25
Oben Installation Services	26 - 27
Custom Base Order	28 -29
Base & Enclosure Technical - Corner	30 - 31
Base & Enclosure Technical - Alcove	32 - 33

Oben makes it easy

TILER



"Oben makes it easy for me to create an exquisite tile shower, every time"

Oben technology - everything a tiler could wish for

- **100% Waterproof** shower base system
- Pre formed slopes **guarantee drainage**
- **Rock-Solid** - no chance of movement
- Compatible with **any** waterproofing system
- Easy and fast to tile - **no crowning**

"With Oben behind us, we say "yes" to every shower request"

Quality and Service you can rely on

BUILDER



- **Established brand** since 1923
- High quality products you can **trust & depend** on
- Design solutions for **every shape** of shower
- **On time deliveries** - each time - every time!
- Hassle-free factory **installation service**

HOME OWNERS



"The whole experience of designing one of the most important areas in our home has been a breeze with Oben"

- Oben brochures **"makes it easy"**!
- **"Peace of Mind"** - 25 year Leak Proof Guarantee
- Full range of tile showers - **Any Shape, Any Size**
- **Total package** - Drains, Base and Frameless Glass
- A choice for **Level Entry** and **Hob** options

"Oben, their precision in design and their history in the market says it all!"

ARCHITECT



- Oben brand - totally **dependable** and trustworthy
- Tiled shower solutions for **new** and **renovations**
- Oben offers the ultimate in **versatility** and luxury
- Sleek minimalist designs - **Function with style**
- Oben enables us to **design** any custom shower

IMAGINE



“The ultimate in versatility and luxury”

Step into luxury with the new range of Oben Walk-in free standing glass panels which do not require an overhead stabilising bar. The simplicity of a single sheet of toughened glass panel creates a luxurious Walk-In shower in any bathroom, the ease of walking into your shower with a low threshold profile and no doors to negotiate needs little explanation.

solaire® Base Walk-In Options

CORNER RECTANGLE

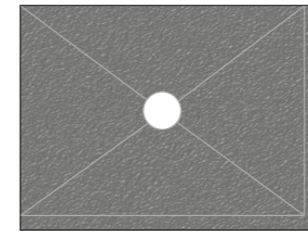

Centre Outlet
RH Base

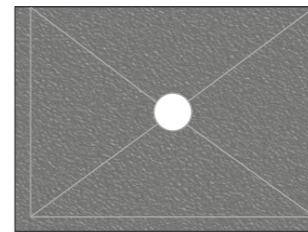

Centre Outlet
LH Base

DEPTH X WIDTH
900 X 1200
900 X 1300
900 X 1400
900 X 1500
900 X 1600
900 X 1700
900 X 1800
900 X 1900
900 X 2000

1000 X 1200
1000 X 1300
1000 X 1400
1000 X 1500
1000 X 1600
1000 X 1700
1000 X 1800
1000 X 1900
1000 X 2000

FEATURES – solaire® Base

- Designed for Timber & Concrete floor installations
- Preformed slopes guarantee drainage
- Rock-Stone® base system 100% Waterproof
- Easy and fast to tile (faceted planes, no crowning)
- Available in modern **Ultra Low Threshold** 50mm profile or Minimalistic flush **Level Entry** design
- Compatible with any Certified Waterproofing system
- Base lengths up to 2400mm
- Standard centre drain outlet (Custom outlet made to order)
- Base Adhesive Kit included:
 1. **Polyurethane Kit** (Tile & Slate Underlay Floors)
 2. **Tile Adhesive Kit** (Concrete Floors)
- Drain options:
 1. “J” Gully Waste
 2. Easy Clean Waste

Base Hand must be specified at time of order

ENCLOSURE – FRAMELESS GLASS

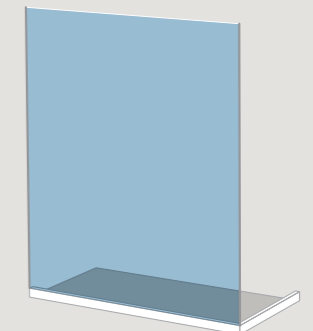

FIXED PANEL

FEATURES – Enclosure

- 10mm thick Toughened Safety Glass
- Reversible Left and Right Hand Panels
- No stabilising over panel required
- Glass height – 1960 (Standard)
- Custom glass height – Made to Order
- Glass Panel Width (Standard)
900, 950, 1000, 1100, 1200



LUXURIATE



“Let yourself be inspired”

The latest in minimalistic 10mm glass makes the slide shower an impressive design statement. Extra smooth stainless steel roller technology provides for smooth and effortless door opening and closing action. Minimalistic in appearance, this modern frameless sliding glass enclosure provides that truly “Frameless look” and is the flagship of the Oben shower range.

solaire® Base Slide Shower Options

SLIDE SHOWER

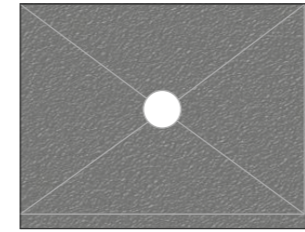

Centre Outlet
RH Base

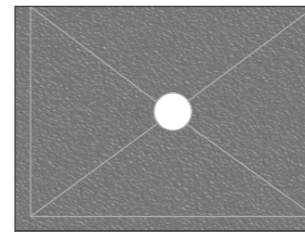

Centre Outlet
LH Base

DEPTH X WIDTH
900 X 1200
900 X 1300
900 X 1400
900 X 1500
900 X 1600
900 X 1700
900 X 1800
900 X 1900
900 X 2000

1000 X 1200
1000 X 1300
1000 X 1400
1000 X 1500
1000 X 1600
1000 X 1700
1000 X 1800
1000 X 1900
1000 X 2000

FEATURES - solaire® Base

- Designed for Timber & Concrete floor installations
- Preformed slopes guarantee drainage
- Rock-Stone® base system 100% Waterproof
- Easy and fast to tile (faceted planes, no crowning)
- Available in modern **Ultra Low Threshold** 50mm profile or Minimalistic flush **Level Entry** design
- Compatible with any Certified Waterproofing system
- Base lengths up to 2400mm
- Standard centre drain outlet (Custom outlet made to order)
- Base Adhesive Kit included:
 1. **Polyurethane Kit** (Tile & Slate Underlay Floors)
 2. **Tile Adhesive Kit** (Concrete Floors)
- Drain options:
 1. “J” Gully Waste
 2. Easy Clean Waste

Base Hand must be specified at time of order

ENCLOSURE - FRAMELESS GLASS

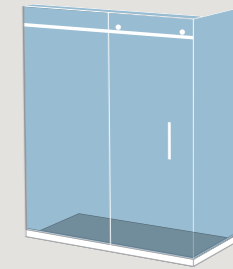

2 PANEL
SLIDING DOOR
RH Door Shown

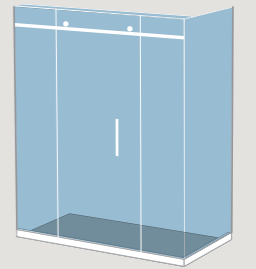

3 PANEL
SLIDING DOOR
RH Door Shown

FEATURES - Enclosure

- 10mm thick Toughened Safety Glass
- Reversible Left and Right Hand Doors
- Easy glide Stainless Steel roller wheels
- Glass height - 2050 (Standard)
- Custom glass height - Made to Order
- Available in Corner or Alcove options
Size Range 1200 - 2000



RELAX

solaire® Base Rectangular Corner Options

CORNER RECTANGLE

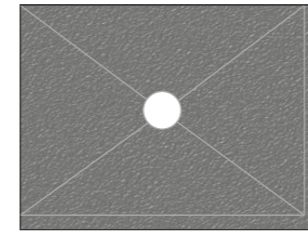

Centre Outlet
RH Base

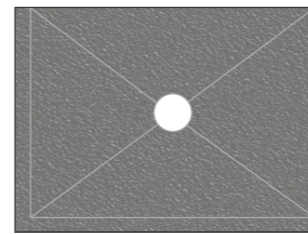

Centre Outlet
LH Base

DEPTH X WIDTH
900 X 1200
900 X 1300
900 X 1400
900 X 1500
900 X 1600
900 X 1700
900 X 1800
900 X 1900
900 X 2000

1000 X 1200
1000 X 1300
1000 X 1400
1000 X 1500
1000 X 1600
1000 X 1700
1000 X 1800
1000 X 1900
1000 X 2000

ENCLOSURE - FRAMELESS GLASS

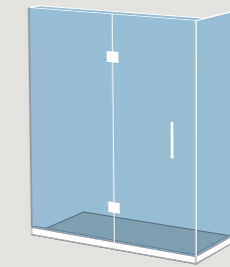

OFFSET DOOR
LH Hinge Shown

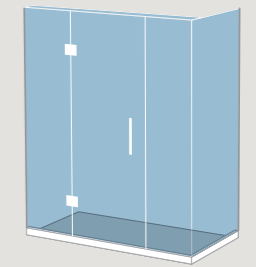

CENTRE DOOR
LH Hinge Shown

FEATURES - Enclosure

- 10mm thick Toughened Safety Glass
- Reversible Left and Right Hand Doors
- Door width 690mm (590mm optional)
- Centre and Offset door options
- Glass Over Panel (Standard)
- Glass height - 1960 (Standard)
- Custom glass height - Made to Order
- Glass Panel Width (Standard) 900 - 2000mm

FEATURES - solaire® Base

- Designed for Timber & Concrete floor installations
- Preformed slopes guarantee drainage
- Rock-Stone® base system 100% Waterproof
- Easy and fast to tile (faceted planes, no crowning)
- Available in modern **Ultra Low Threshold** 50mm profile or Minimalistic flush **Level Entry** design
- Compatible with any Certified Waterproofing system
- Base lengths up to 2400mm
- Standard centre drain outlet (Custom outlet made to order)
- Base Adhesive Kit included:
 1. **Polyurethane Kit** (Tile & Slate Underlay Floors)
 2. **Tile Adhesive Kit** (Concrete Floors)
- Drain options:
 1. "J" Gully Waste
 2. Easy Clean Waste

Base Hand must be specified at time of order



"Extra Large for Showering Luxury"

Corner frameless shower opens up rooms and let light flood in, transforming ordinary bathrooms into inspirational and relaxing spaces. The rectangular corner has an offset door to allow for the widest possible entrance with 10mm solid frameless glass for that luxurious feel.

REVITALISE

solaire® Base Square Corner Options

CORNER CENTRE OUTLET

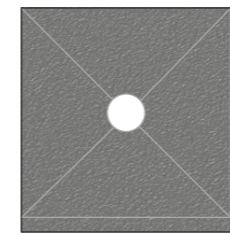

Centre Outlet

DEPTH X WIDTH
800 X 800
850 X 850
900 X 900
950 X 950
1000 X 1000
1050 X 1050
1100 X 1100
1150 X 1150
1200 X 1200

ENCLOSURE - FRAMELESS GLASS

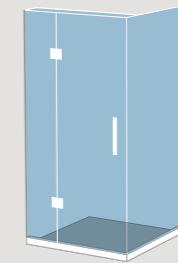

OFFSET DOOR
LH Hinge Shown

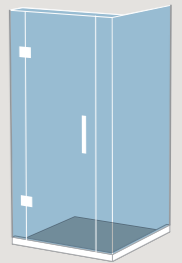

CENTRE DOOR
LH Hinge Shown

FEATURES - Enclosure

- 10mm thick Toughened Safety Glass
- Reversible Left and Right Hand Doors
- Door width 690mm (590mm optional)
- Centre and Offset door options
- Glass Over Panel (Standard)
- Glass height - 1960 (Standard)
- Custom glass height - Made to Order

FEATURES - solaire® Base

- Designed for Timber & Concrete floor installations
- Preformed slopes guarantee drainage
- Rock-Stone® base system 100% Waterproof
- Easy and fast to tile (faceted planes, no crowning)
- Available in modern **Ultra Low Threshold** 50mm profile or Minimalistic flush **Level Entry** design
- Compatible with any Certified Waterproofing system
- Base lengths up to 2400mm
- Standard centre drain outlet (Custom outlet made to order)
- Base Adhesive Kit included:
 1. **Polyurethane Kit** (Tile & Slate Underlay Floors)
 2. **Tile Adhesive Kit** (Concrete Floors)
- Drain options:
 1. "J" Gully Waste
 2. Easy Clean Waste

Base Hand must be specified at time of order



“Adding new dimension to space”

Oben's unique Square Corner features a glass return wall which gives the appearance of added space and light, bringing a whole new dimension to your bathroom. Manufactured from 10mm toughened safety glass with a single door available in left or right hand options, also featuring a low profile threshold for that minimalist look.

INVIGORATE

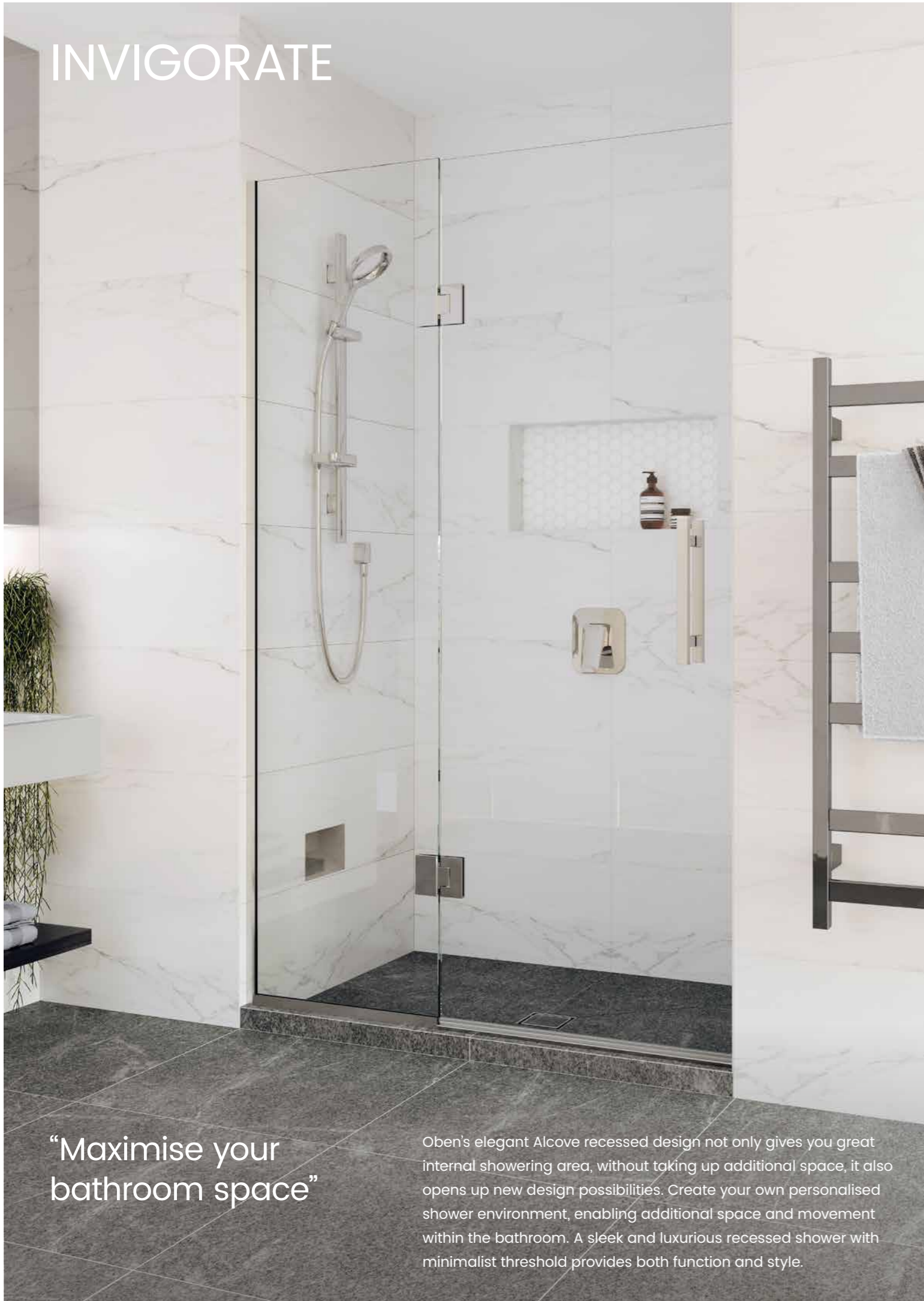

“Maximise your bathroom space”

Oben's elegant Alcove recessed design not only gives you great internal showering area, without taking up additional space, it also opens up new design possibilities. Create your own personalised shower environment, enabling additional space and movement within the bathroom. A sleek and luxurious recessed shower with minimalist threshold provides both function and style.

solaire® Base Alcove Options

ALCOVE RECTANGLE

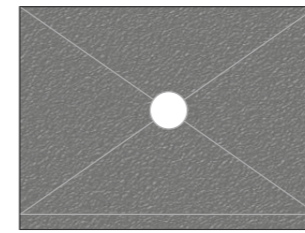

Centre Outlet

DEPTH 1	DEPTH 2	WIDTH
900	N/A	x 1000
900	1000	x 1100
900	1000	x 1200
900	1000	x 1300
900	1000	x 1400
900	1000	x 1500
900	1000	x 1600
900	1000	x 1700
900	1000	x 1800
900	1000	x 1900
900	1000	x 2000

ALCOVE SQUARE

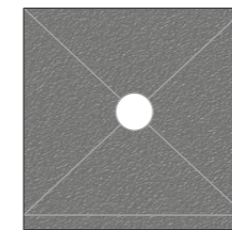

Centre Outlet

DEPTH X WIDTH
900 X 900
1000 X 1000
1100 X 1100
1200 X 1200

FEATURES - solaire® Base

- Designed for Timber & Concrete floor installations
- Preformed slopes guarantee drainage
- Rock-Stone® base system 100% Waterproof
- Easy and fast to tile (faceted planes, no crowning)
- Available in modern **Ultra Low Threshold** 50mm profile or Minimalistic flush **Level Entry** design
- Compatible with any Certified Waterproofing system
- Base lengths up to 2400mm
- Standard centre drain outlet (Custom outlet made to order)
- Base Adhesive Kit included:
 1. **Polyurethane Kit** (Tile & Slate Underlay Floors)
 2. **Tile Adhesive Kit** (Concrete Floors)
- Drain options:
 1. "J" Gully Waste
 2. Easy Clean Waste

Base Hand must be specified at time of order

ENCLOSURE - FRAMELESS GLASS

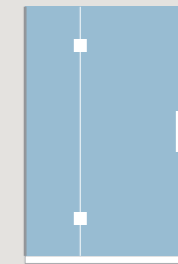

OFFSET DOOR
LH Hinge Shown

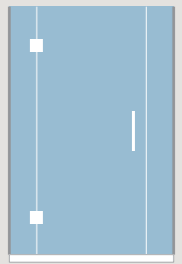

CENTRE DOOR
LH Hinge Shown

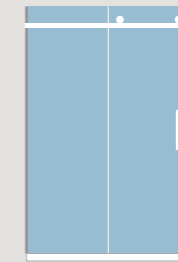

2P SLIDING DOOR
RH Door Shown



FIXED PANEL
LH Panel Shown

FEATURES - Enclosure

- Glass Height:
 - Hinge Model 1960mm
 - Door Width 690 / 590mm
 - Glass Over Panel (Standard)
 - Sliding Model 2050mm
- Custom glass height - Made to Order



ENJOY

solaire® Base Neo-Angle Options

NEO-ANGLE CENTRE OUTLET

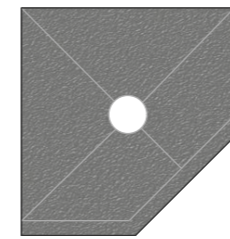

Centre Outlet

DEPTH X WIDTH
900 X 900
950 X 950
1000 X 1000

ENCLOSURE - FRAMELESS GLASS

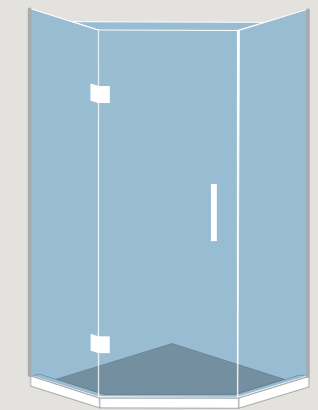

CENTER DOOR
LH Hinge Shown

FEATURES - Enclosure

- Reversible Left and Right Hand Doors
- Door width 690mm (590mm optional)
- Glass Over Panel (Standard)
- Glass height - 1960 (Standard)
- Custom glass height - Made to Order

FEATURES - solaire® Base

- Designed for Timber & Concrete floor installations
- Preformed slopes guarantee drainage
- Rock-Stone® base system 100% Waterproof
- Easy and fast to tile (faceted planes, no crowning)
- Available in modern **Ultra Low Threshold** 50mm profile or Minimalistic flush **Level Entry** design
- Compatible with any Certified Waterproofing system
- Base lengths up to 2400mm
- Standard centre drain outlet (Custom outlet made to order)
- Base Adhesive Kit included:
 1. **Polyurethane Kit** (Tile & Slate Underlay Floors)
 2. **Tile Adhesive Kit** (Concrete Floors)
- Drain options:
 1. "J" Gully Waste
 2. Easy Clean Waste

Base Hand must be specified at time of order



"Where space is a luxury"

Oben's practical, space saving Neo Angle corner shower not only maximises space, it also makes the most out of what you can do in a space devoted entirely to indulgence, relaxation and wellbeing. Neo Angle is made from 10mm frameless toughened safety glass and comes with a single door in left or right hand options.

Shower niches

When remodelling a bathroom, consider adding a recessed shower niche into your design. It's a practical and streamlined way to add storage space for shampoos, soaps and accessories within your shower wall cavity, without taking away valuable elbow room.

Oben built-in recessed shower niches are a great alternative to chunky glass corner shelves and shower caddies. Available in a wide range of shapes and sizes to suit every installation.



MITRED EDGE



EXTERNAL EDGE FINISHES

A mitred tile edge will give your niche that professional stylish designer look. Ask your tiler to quote mitred edges, which is where the tiles are cut on a 45-degree angle so that the tile edges meet therefore eliminating the necessity for tile trims. Alternatively aluminium tile trim extrusions are available in a range of finishes.

FOOT REST

Oben's recessed Foot Rest offers a practical solution to shave your legs easily and safely in the shower.



NICHE 600 X 300

Adding a wall niche is a very practical and elegant way to create more storage space in your bathroom. Recessed wall niches enhance your bathroom design and provide a place to conveniently stow all your shampoos, shower gels and other shower items. Available in a range of sizes to match any bathroom style.



NICHE 300 X 300 His 'n' Hers®

Accessories as shown not included

What is Glide Glass®

THE NON-STICK EASY-CLEAN GLASS

Glide Glass® is proprietary protective nano coating developed by Oben.

A long lasting protective coating for glass showers, making glass easier to clean and maintain like new.

Glide Glass reduces cleaning time by repelling lime scale and soap residue deposits from adhering to the glass surface, which results in significantly reduced time and effort for cleaning.

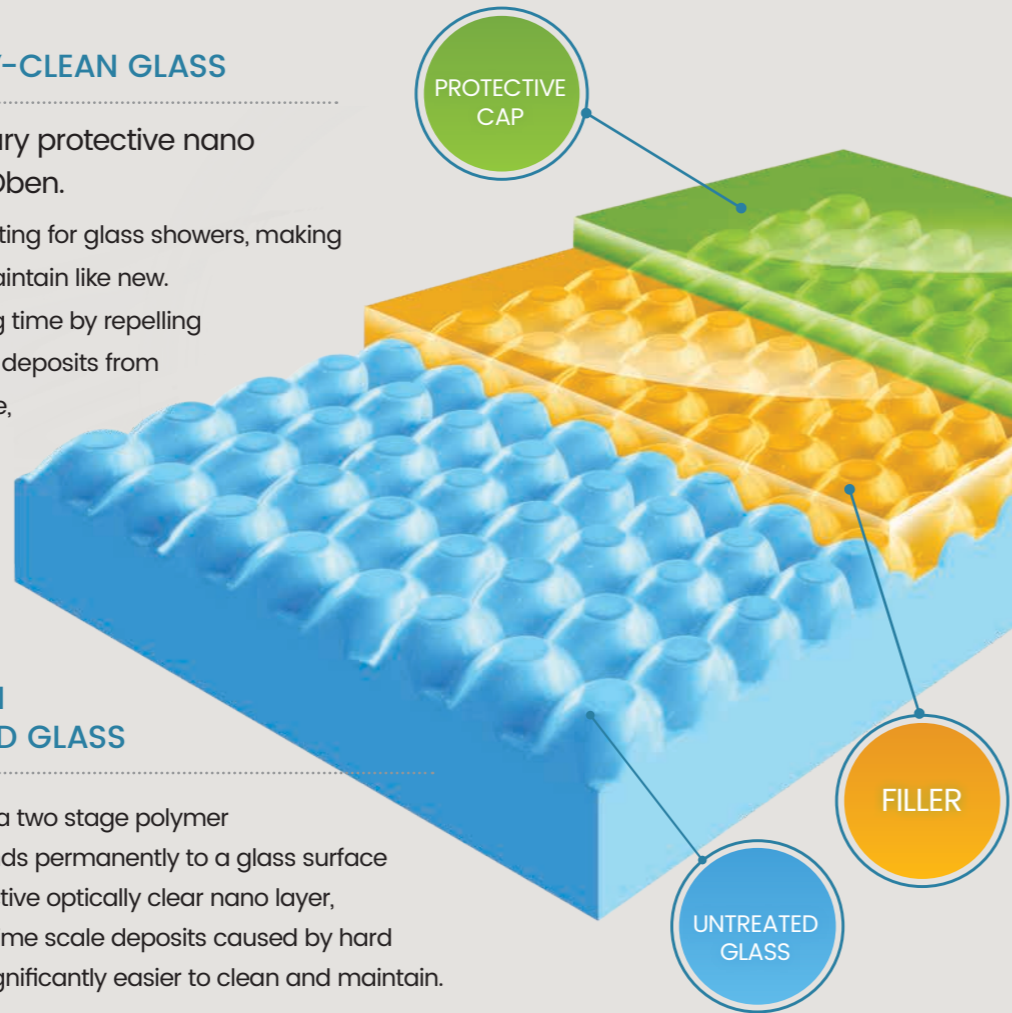

WHAT IS THE DIFFERENCE BETWEEN TREATED & UNTREATED GLASS

Glide Glass® treated glass is a two stage polymer chemical reaction which bonds permanently to a glass surface providing an ultra thin protective optically clear nano layer, resistant to soap scum and lime scale deposits caused by hard water, making the surface significantly easier to clean and maintain.

MAKES GLASS EASIER TO CLEAN AND MAINTAIN LIKE NEW.

- Highly water repellent (Hydrophobic)
- Resistant to Hard water
- Less frequent cleaning
- Reduces mould & bacteria build up

UNTREATED GLASS

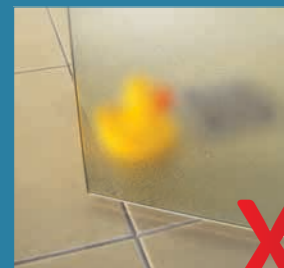

TREATED GLASS



Glide Glass®

Keeps your frameless glass shower looking like new!



NON-STICK, EASY-CLEAN GLASS

Glide Glass® - Optional Extra, only available for **NEW** glass installations and must be specified at time of frameless glass shower order.

Average price for **Glide Glass®** Nano application per shower approximately \$150 - \$350 depending on shower size, includes Consumer Care & Maintenance Kit.

Product Finishes

HANDLES

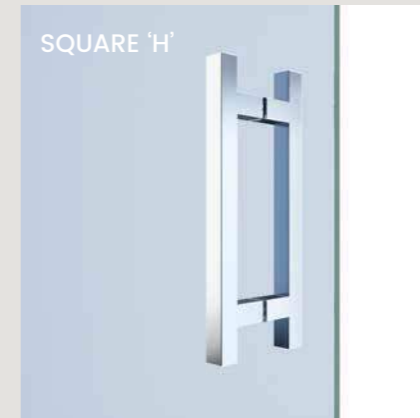

HINGES



FINISHES



CHROME
(Standard)



BRUSHED STAINLESS
(Non-Standard)

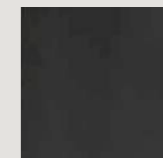

MATT BLACK
(Non-Standard)



WHITE
(Non-Standard)

Note: Surcharge applies to non-standard finishes

OBEN PRODUCT WARRANTY SCHEDULE

CATEGORY	NON COMMERCIAL USE	
Rock-Stone® Shower Bases	25 Year	
Rock-Stone® Niches	25 Year	
Rock-Stone® Hobs	25 Year	
Shower Drains	15 Year (Excludes powder-coated finishes*)	
Showers (Glass & Hardware)	5 Year	
Mirrors	1 Year (Excludes mirrors installed directly on to vanity top)	
Shower Seals (Vinyl/PVC)	1 Year	

*Powder-coated Drains - Matt Black and White drain finishes available on request but supplied **No Warranty**
Powder-coated finishes are not suitable for drain installations. Oben recommends Stainless Steel finishes only which is covered by Oben 15 year warranty. Refer to www.oben.co.nz for further warranty Terms & Conditions

Rock-Stone® Base Polyceramic "Rock Solid" – Foundation

2 ROCK-SOLID CONSTRUCTION

The cement-coated surface forms an in-credibly strong and stable base for ceramic tile adhesive.

- Polyceramic Layer
- Reinforcing mesh
- Cross-linked HD XPS Core
- Brick mesh
- Polymer Cement layer

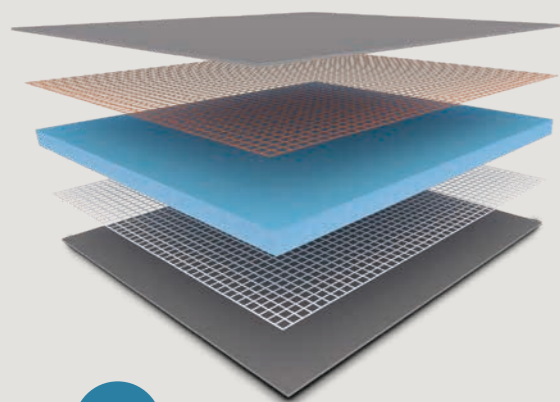

9 25 YEAR WARRANTY*

The 25-year quality guarantee applies to the entire Rock-Stone® base range. Oben is setting new standards when it comes to quality leadership.

3

100% WATERPROOF

The high density 50kg/m³ closed cell cross linked XPS core is 100 % waterproof.

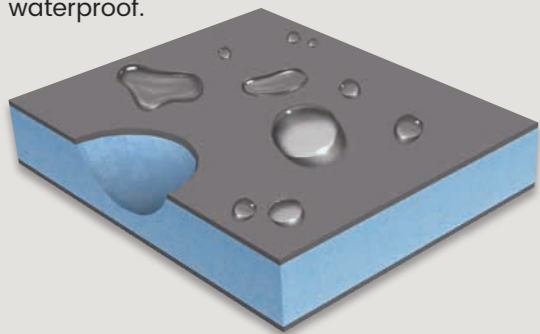

POLYURETHANE ADHESIVE KIT



CEMENTITIOUS ADHESIVE KIT



OR

4 ADHESIVE KITS

Base Adhesive Kit included

1

Precise flat planes for easy tiling, no crowning.

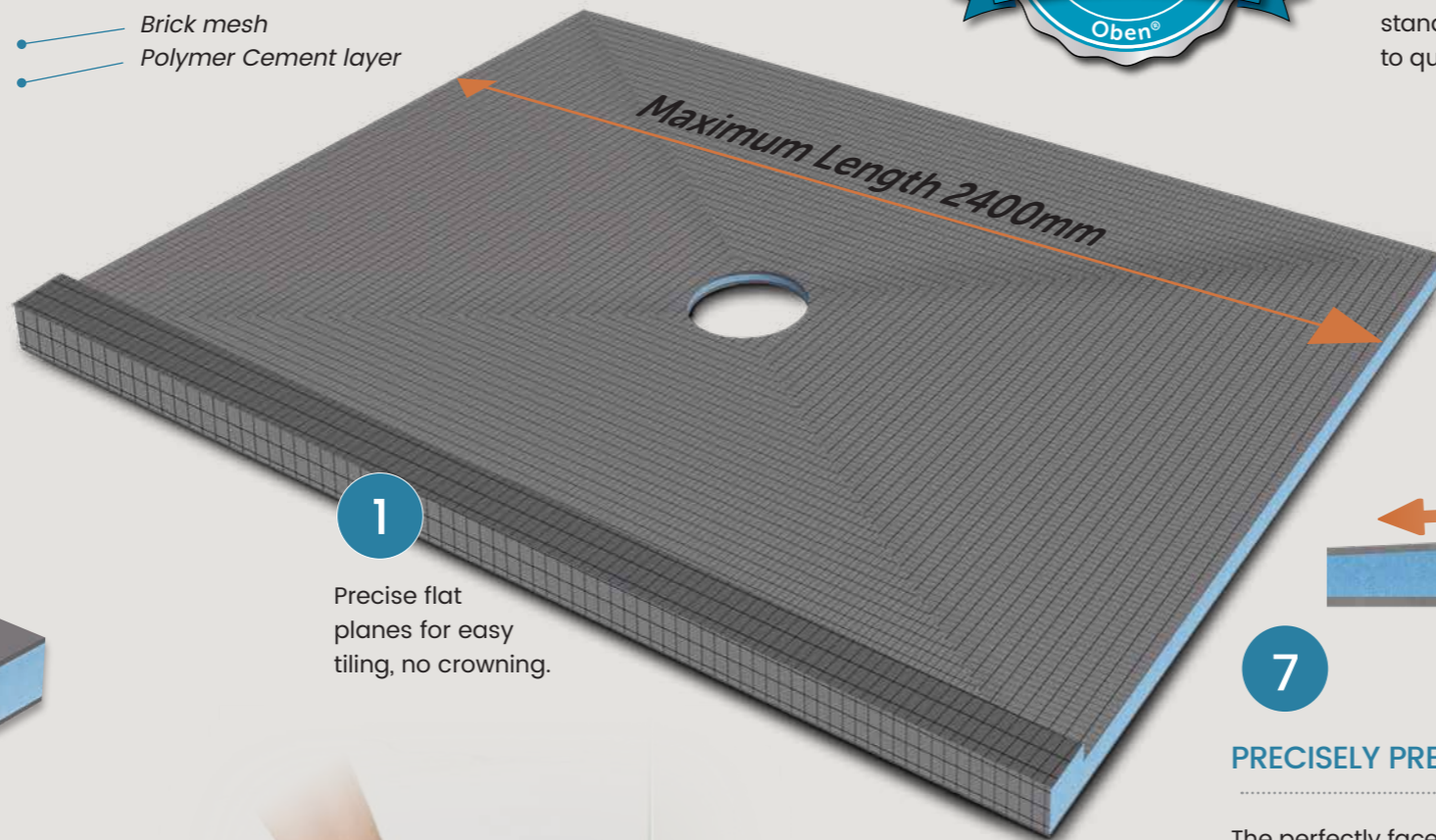

7

PRECISELY PRE-FABRICATED SLOPE

The perfectly faceted slope ensures optimum tiling. Pre-Formed slope guarantees surface drainage.

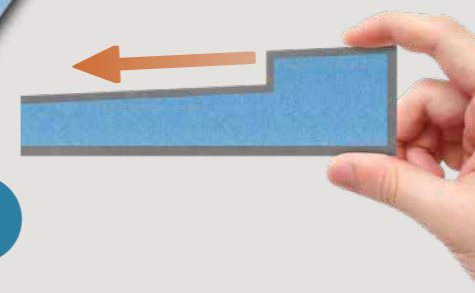

5

LOW HOB DESIGN

Ultra modern low profile design. Only 50mm step in height

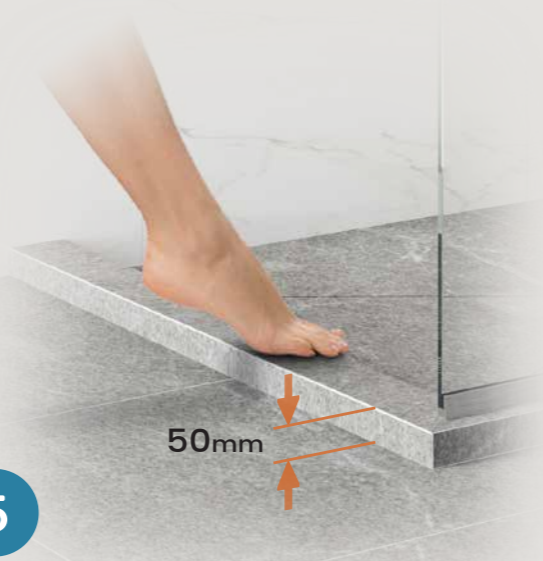

6

PRODUCT RANGE

More options, more shapes! Sizes from 800 mm wide to 2000 mm long as well as Centre and Offset drain outlet positions.

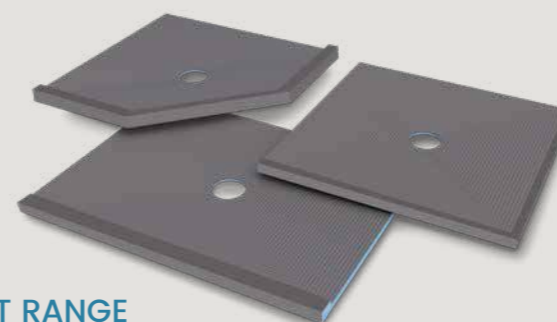

Rock-Stone® Key Features and Benefits



100% Waterproof



Save up to 50% on installation time



Guaranteed slope angle to drain



Superior strength and impact resistance



Easily installed



Suitable for all tile sizes



Easily cut



Superior thermal insulating qualities



Superior sound insulating qualities



Dimensionally stable

Recessed Tile Niches

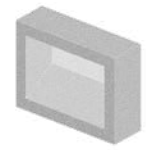

FOOT REST

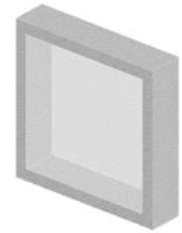

SQUARE

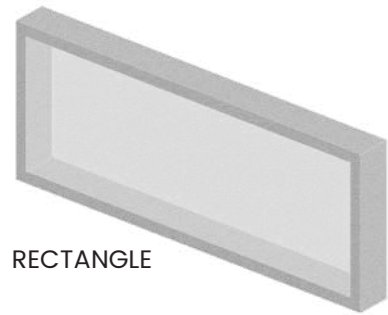

RECTANGLE

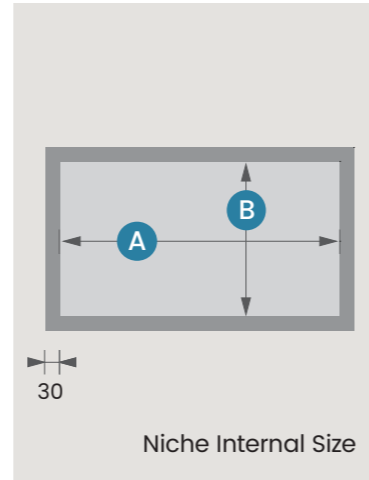
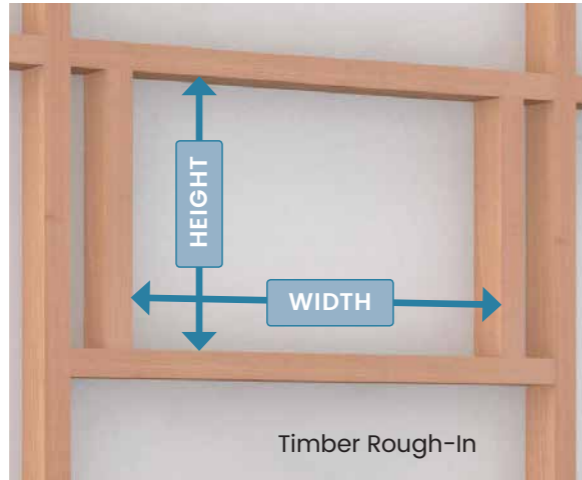

RECESSED NICHE 95MM STUD

Type	Model	Timber Rough-In			Niche Internal Size	
		Width	Height	Depth	A	B
Foot Rest		300	250	95	235	185
Square	300 X 300	400	400	95	335	335
Rectangle	600 X 300	700	400	95	635	335
Rectangle	800 X 300	900	400	95	835	335
Rectangle	900 X 300	1000	400	95	935	335
Rectangle	1000 X 300	1100	400	95	1035	335
Rectangle	1200 X 300	1300	400	95	1235	335
Rectangle	1500 X 300	1600	400	95	1535	335

*Also available in 75mm stud depth on request



1 Rough-In timber framing to support niche - Ref (Niche Rough-In Guide)



2 Fix Gib / Villa Board, dry fit niche, remove and apply adhesive



3 Install niche, ensuring front face is flush with front face of Gib/Villa Board

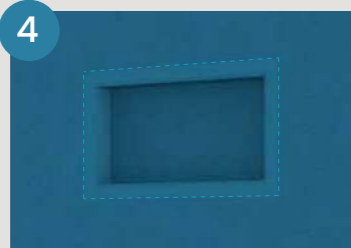

4 Apply Butyl Tapes and waterproof wall and niche

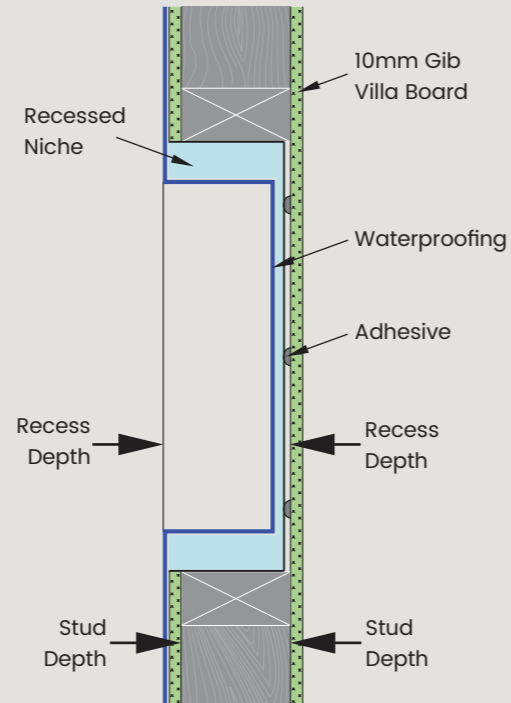

Oben Tile Drains



J GULLY HI FLOW TILE DRAIN
100 x 50

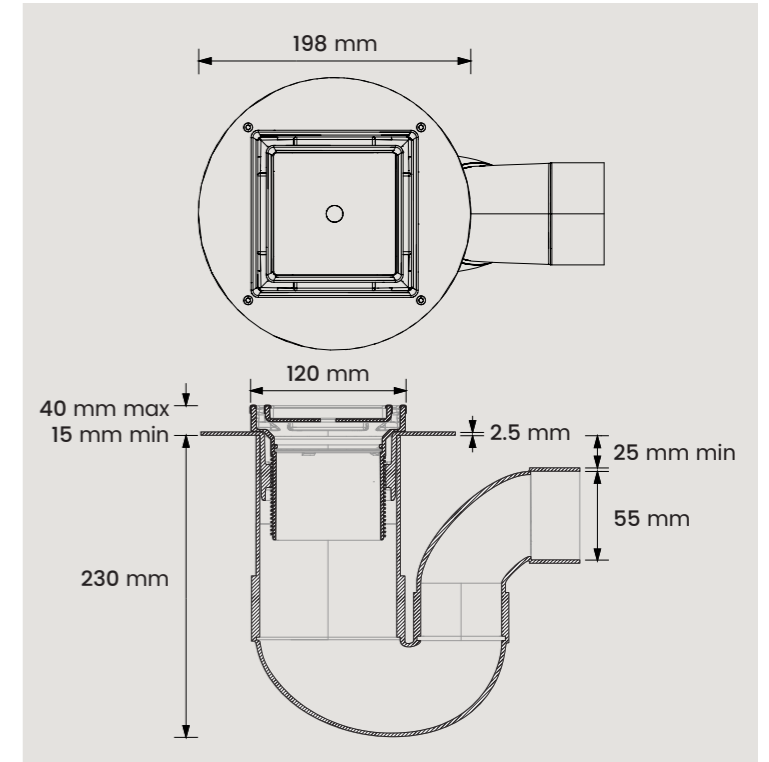

EASY CLEAN TILE DRAIN
100 x 50

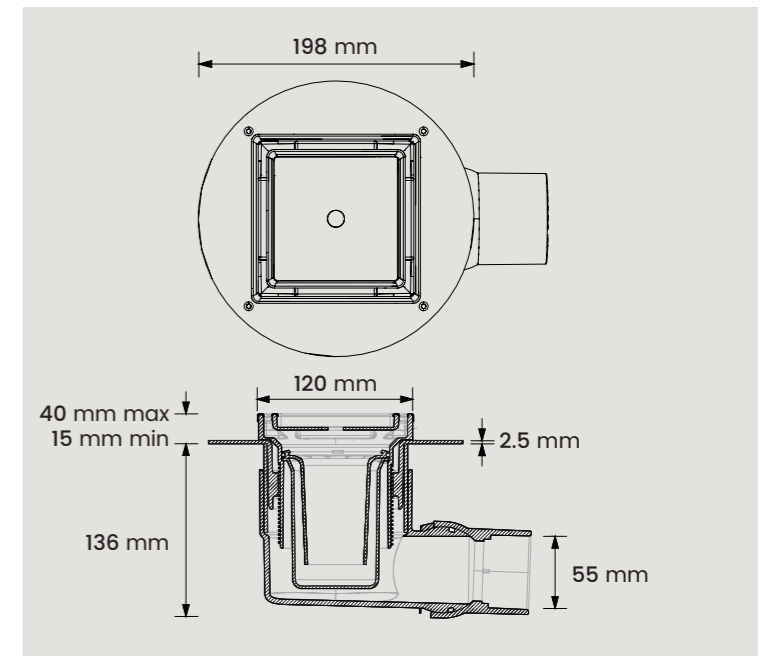

AN INVISIBLE DRAIN SOLUTION

Oben's NEW tile insert drain eliminates the need for a traditional grate in your shower.

The tile insert drain cover allows you to create a seamless and almost invisible finish, allowing your shower floor tile choice to become the drain cover.

A small perimeter slot allows water to drain making the drain virtually invisible.

Base installation easy as 1 2 3



POLYURETHANE ADHESIVE KIT



Floor Substrate

- ✓ Ply
- ✓ Timber
- ✓ Tiles Slate
- ✓ Composed sheet

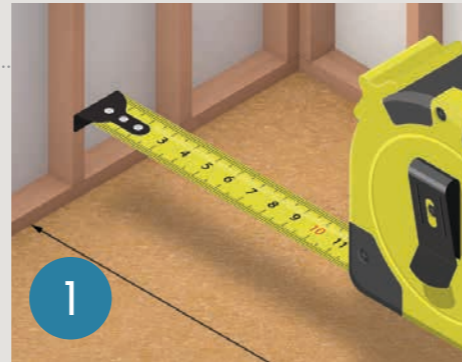

MEASURE



APPLYING POLYURETHANE ADHESIVE

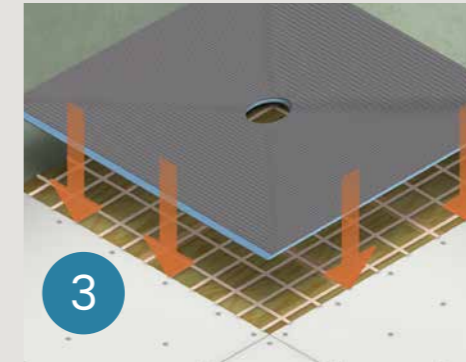

INSTALLING BASE

CEMENTITIOUS ADHESIVE KIT



Floor Substrate

- ✓ Concrete floor



MEASURE



APPLY CEMENTOUS ADHESIVE

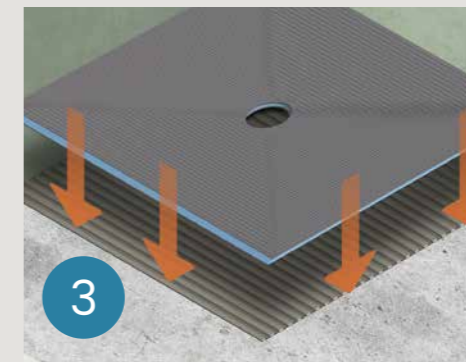

INSTALLING BASE

THE BEST GUARANTEE OF ALL

For over 95 years Oben's founders have set their own benchmark of excellence through innovative design, quality products and a passion for service that continues long after purchase.

All Oben products are made from the highest-quality materials and assembled only by trained craftsmen. Superior design and function are matched by a level of robustness and durability that is, ultimately, **the best guarantee** of all.



A PERFECT FIT EVERY TIME

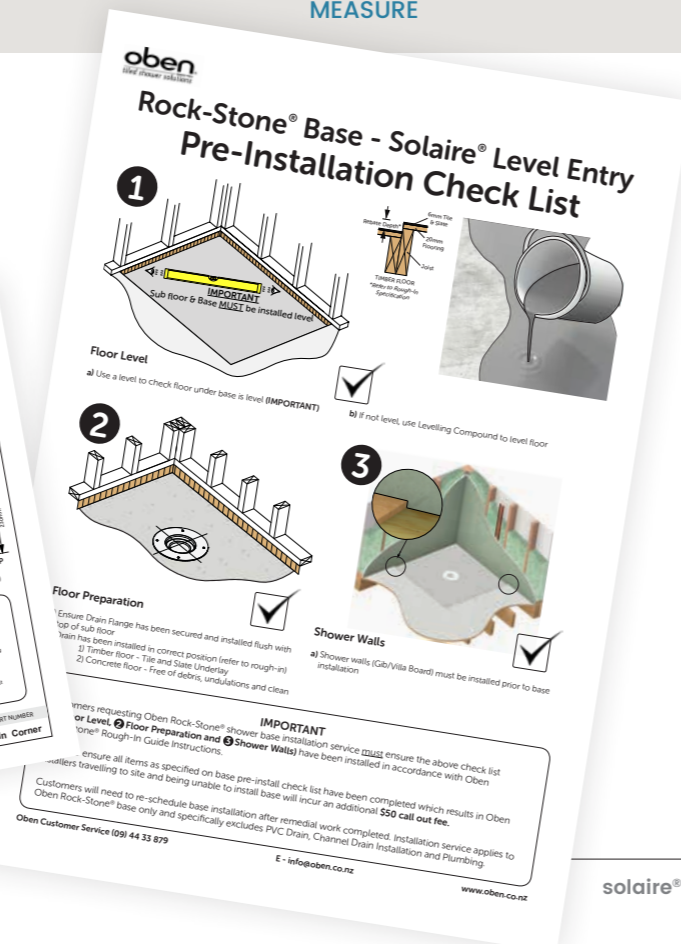
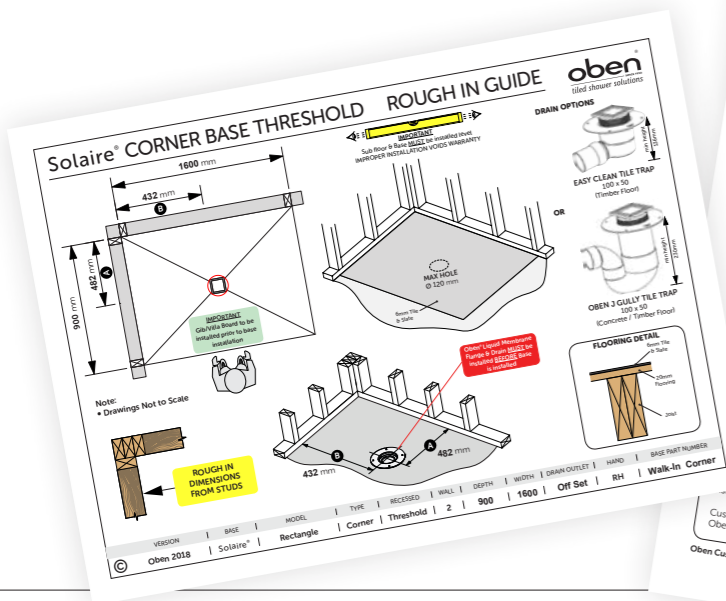

Delivery Nation wide



CALL oben.

T 09 44 33 879

E sales@oben.co.nz

W www.oben.co.nz

Order custom size

CREATING YOUR CUSTOM SIZE SHOWER IS EASY WITH OBEN

**ANY SHAPE
ANY SIZE**

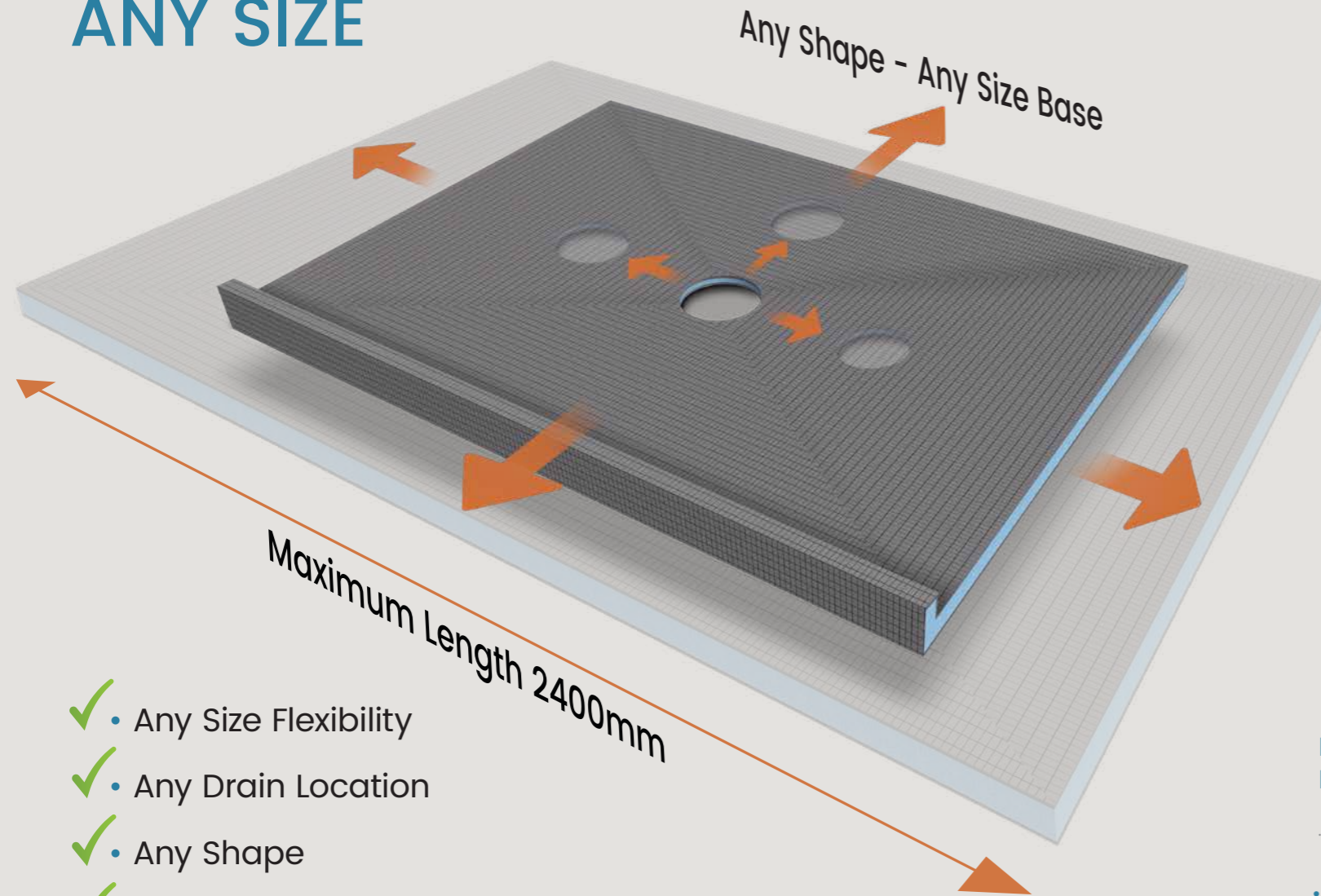

- ✓ • Any Size Flexibility
- ✓ • Any Drain Location
- ✓ • Any Shape
- ✓ • Level Entry & Treshold

Rock-Stone® Bases are custom made to your exact dimensions ensuring

A PERFECT FIT EVERY TIME

ORDERING YOUR SHOWER

XPS CAD
Base Design



DESIGN EXPERTISE KNOW HOW

- Rough-In Drawings ✓
- Technical Installation ✓

ORDER STEPS

- **STEP 1** - Call / Email
- **STEP 2** - Discuss
- **STEP 3** - Design
- **STEP 4** - Delivery



solaire® Base Installation

Threshold Bases

Oben makes it Easy!

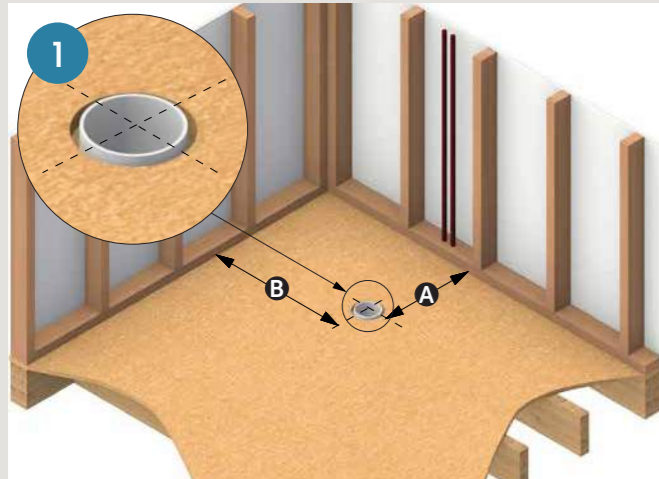

Install PVC drain pipe through sub floor, for (A) & (B) set out dimensions off studs refer to Rough-In Guide

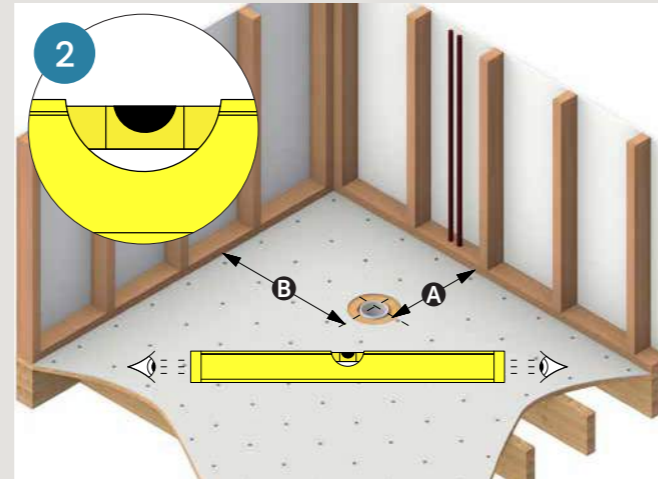

Lay 6mm Tile & Slate/Compressed Sheet over sub floor, cut circular clearance hole for LM Flange. Floor MUST be level

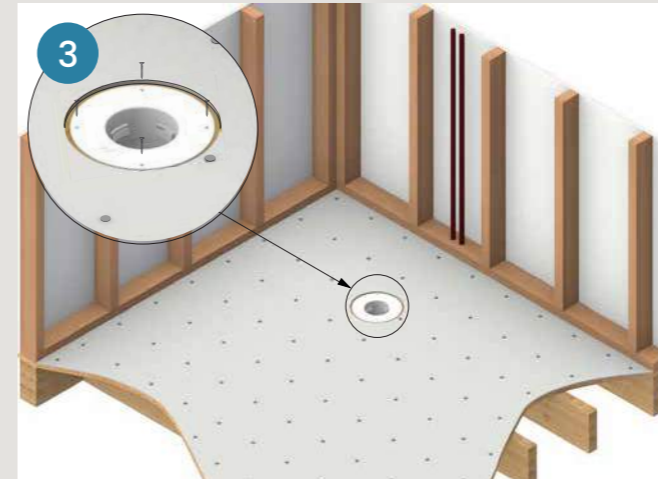

Install liquid membrane flange to PVC drain and secure to sub floor

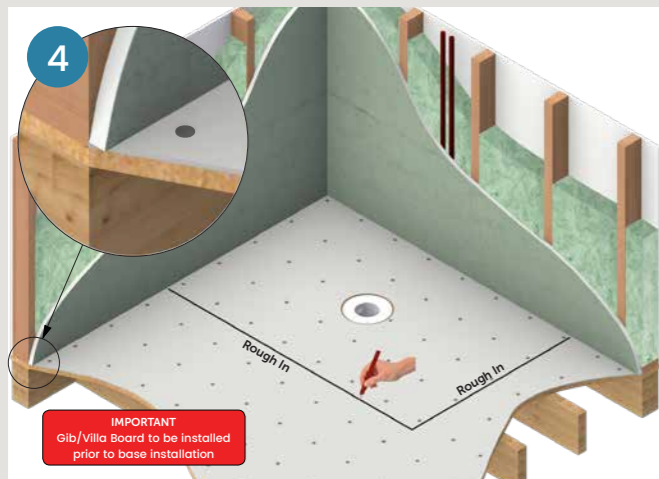

Install Gib/Villa board walls ensuring it is installed down to floor substrate. Dry fit base and mark outline shape on floor

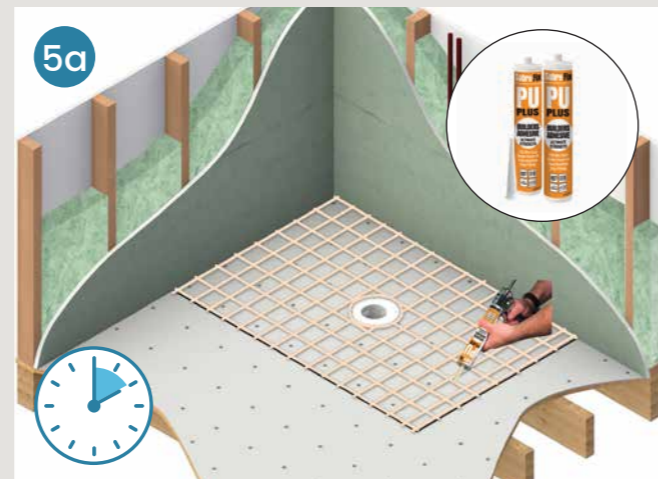

Tile and Slate Floor - Apply polyurethane adhesive. 2 hour cure time (Adhesive Kit included)

OR

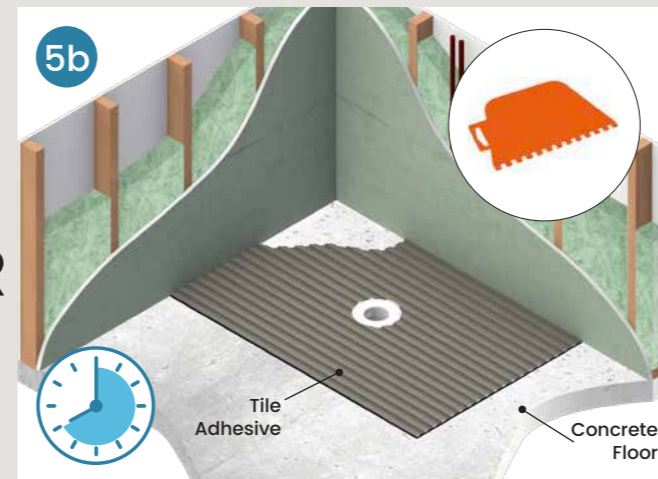

Concrete Floor - Mix tile adhesive and apply with trowel up to outlined base area. 8 hour cure time

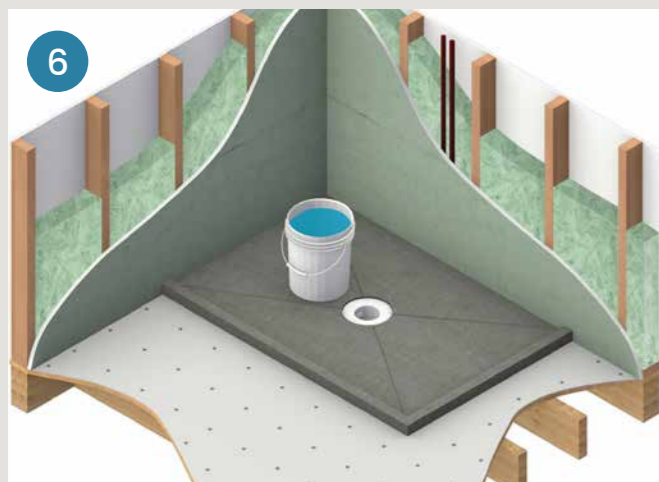

Fit Solaire® base and weigh down with adhesive pale filled with water

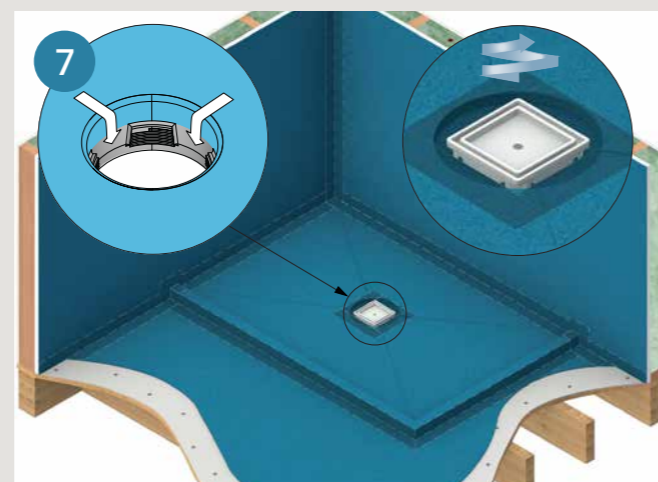

Apply butyl tapes and waterproof floor and walls. Screw the centre drain tile insert component into the LM flange

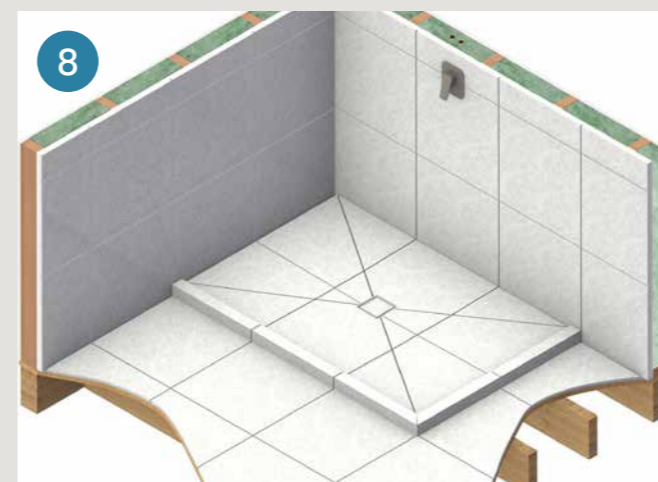

Tile walls and base. Grout and silicone seal all corner joints. Tile centre waste insert

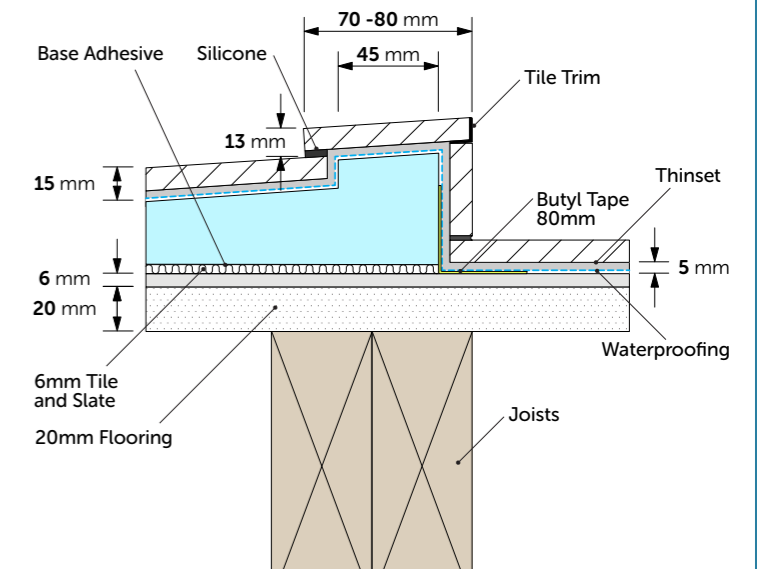

Concrete Floor - Mix tile adhesive and apply with trowel up to outlined base area. 8 hour cure time

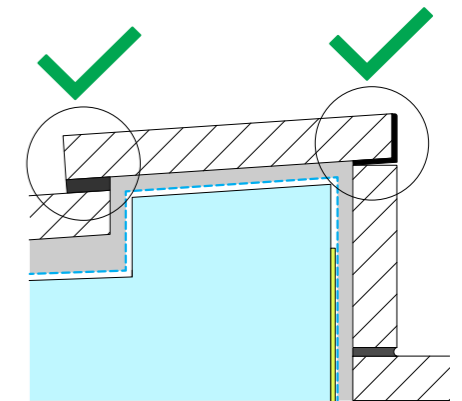

Concrete Floor - Mix tile adhesive and apply with trowel up to outlined base area. 8 hour cure time

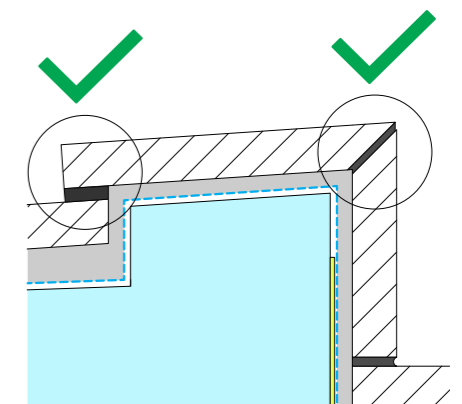

Concrete Floor - Mix tile adhesive and apply with trowel up to outlined base area. 8 hour cure time

Apply butyl tapes and waterproof floor and walls as shown

solaire® Threshold – Corner Technical

ROCK-STONE® BASE AVAILABILITY ● Ex Stock ● Made To Order (5 working days) ● Glass Availability

CORNER – CENTRE OUTLET

Corner Square

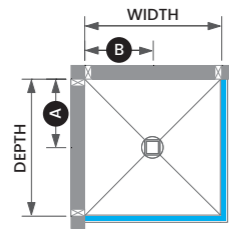
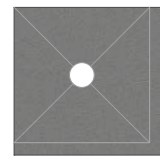

Right Hand Base

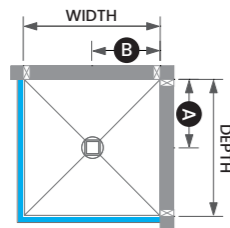

Left Hand Base

Size	Rock-Stone® Base		Drain Outlet		THRESHOLD	Threshold Height	Availability
	Depth	Width	A	B			
800 X 800	790	790	382	382		50	●
850 X 850	840	840	408	408		50	●
900 X 900	890	890	432	432		50	●
950 X 950	940	940	458	458		50	●
1000 X 1000	990	990	482	482		50	●
1050 X 1050	1040	1040	508	508		50	●
1100 X 1100	1090	1090	532	532		50	●
1200 X 1200	1190	1190	582	582		50	●

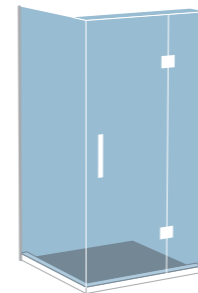

RH Hinge shown

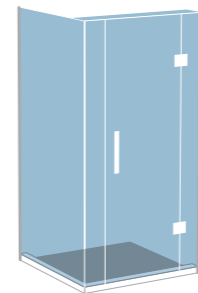

RH Hinge shown

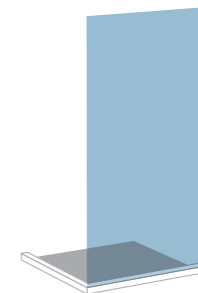

LH Door shown

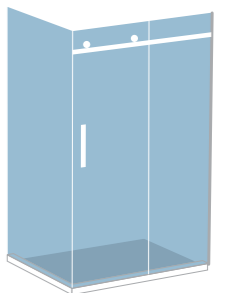

LH Door shown

	DOOR OFFSET (Reversible)	DOOR CENTRE (Reversible)	FIXED PANEL (Reversible)	WALK-IN (Reversible)	2-P SLIDING (Reversible)
●	●	●	●		
●	●	●	●		●
●	●	●	●		●
●	●	●	●		●
●	●	●	●		●
●	●	●	●	●	●
●	●	●	●	●	●
●	●	●	●	●	●
●	●	●	●	●	●
●	●	●	●	●	●
●	●	●	●	●	●

Corner Rectangle

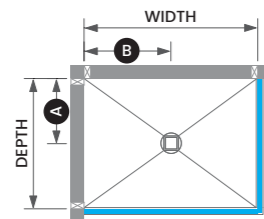
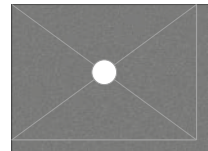

Right Hand Base

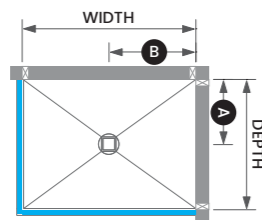

Left Hand Base

900 X 1000	890	990	432	482	50	●
900 X 1100	890	1090	432	532	50	●
900 X 1200	890	1190	432	582	50	●
900 X 1300	890	1290	432	632	50	●
900 X 1400	890	1390	432	682	50	●
900 X 1500	890	1490	432	732	50	●
900 X 1600	890	1590	432	782	60	●
900 X 1700	890	1690	432	832	60	●
900 X 1800	890	1790	432	882	60	●
900 X 1900	890	1890	432	932	60	●
900 X 2000	890	1990	432	982	60	●
1000 X 1100	990	1090	482	532	50	●
1000 X 1200	990	1190	482	582	50	●
1000 X 1300	990	1290	482	632	50	●
1000 X 1400	990	1390	482	682	50	●
1000 X 1500	990	1490	482	732	50	●
1000 X 1600	990	1590	482	782	60	●
1000 X 1700	990	1690	482	832	60	●
1000 X 1800	990	1790	482	882	60	●
1000 X 1900	990	1890	482	932	60	●
1000 X 2000	990	1990	482	982	60	●

●	●	●		
●	●	●		●
●	●	●		●
●	●	●		●
●	●	●	●	●
●	●	●	●	●
●	●	●	●	●
●	●	●	●	●
●	●	●	●	●
●	●	●	●	●
●	●	●	●	●
●	●	●	●	●

Corner Neo-Angle

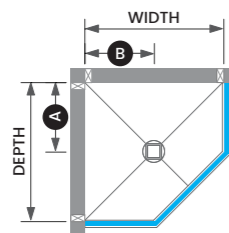
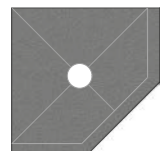

Right Hand Base

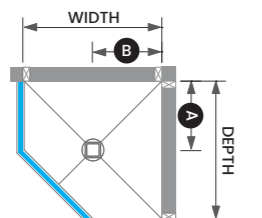

Left Hand Base

Size	Rock-Stone® Base		Drain Outlet		THRESHOLD	Threshold Height	Availability
	Depth	Width	A	B			
900 X 900	890	890	432	432		50	●
950 X 950	940	940	458	458		50	●
1000 X 1000	990	990	482	482		50	●
1100 X 1100	1090	1090	532	532		50	●

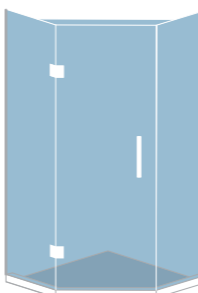

LH Hinge shown

DOOR OFFSET (Reversible)
●
●
●
●
●

WATER DEFLECTOR



Low profile Dam and flexible seal deflect water back into shower

GLASS ADJUSTMENT

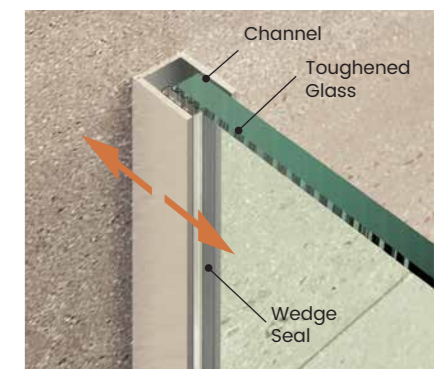

Channel allows glass adjustment for out of square walls (+/- 8 mm)

solaire® Threshold – Alcove Technical

ROCK-STONE® BASE AVAILABILITY ● Ex Stock ● Made To Order (5 working days) ● Glass Availability

ALCOVE – CENTRE OUTLET

Alcove Square

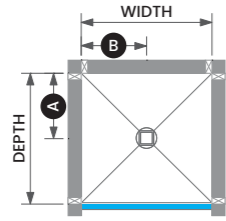
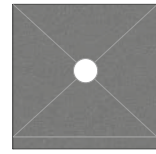

Size	Rock-Stone® Base		Drain Outlet		THRESHOLD Threshold Height	Availability
	Depth	Width	A	B		
800 X 800	790	780	382	400	50	●
850 X 850	840	830	408	425	50	●
900 X 900	890	880	432	450	50	●
950 X 950	940	930	458	475	50	●
1000 X 1000	990	980	482	500	50	●
1050 X 1050	1040	930	508	525	50	●
1100 X 1100	1090	980	532	550	50	●
1200 X 1200	1190	1180	582	600	50	●

Corner Rectangle

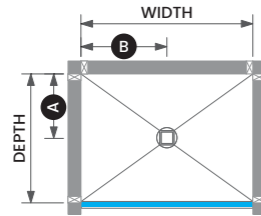
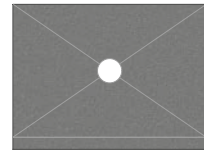

900 X 1000	890	980	432	500	50	●
900 X 1100	890	1080	432	550	50	●
900 X 1200	890	1180	432	600	50	●
900 X 1300	890	1280	432	650	50	●
900 X 1400	890	1380	432	700	50	●
900 X 1500	890	1480	432	750	50	●
900 X 1600	890	1580	432	800	60	●
900 X 1700	890	1680	432	850	60	●
900 X 1800	890	1780	432	900	60	●
900 X 1900	890	1880	432	950	60	●
900 X 2000	890	1980	432	1000	60	●
1000 X 1100	990	1080	482	550	50	●
1000 X 1200	990	1180	482	600	50	●
1000 X 1300	990	1280	482	650	50	●
1000 X 1400	990	1380	482	700	50	●
1000 X 1500	990	1480	482	750	50	●
1000 X 1600	990	1580	482	800	60	●
1000 X 1700	990	1680	482	850	60	●
1000 X 1800	990	1780	482	900	60	●
1000 X 1900	990	1880	482	950	60	●
1000 X 2000	990	1980	482	1000	60	●

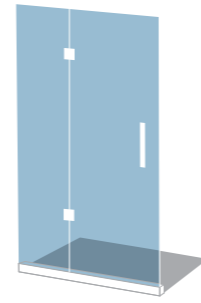

LH Hinge shown

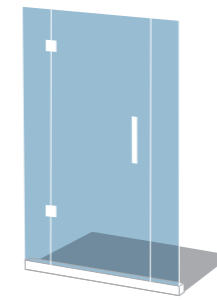

LH Hinge shown

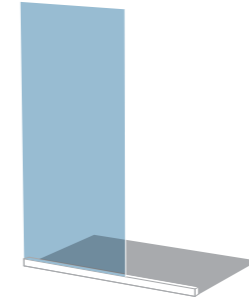

FIXED PANEL
(Reversible)

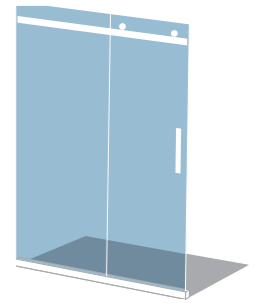

2-P SLIDING
(Reversible)

DOOR OFFSET (Reversible)	DOOR CENTRE (Reversible)	FIXED PANEL (Reversible)	2-P SLIDING (Reversible)
●	●		
●	●		
●	●		
●	●		
●	●		
●	●		
●	●		
●	●		
●	●		
●	●		

●	●		●
●	●		●
●	●		●
●	●	●	●
●	●	●	●
●	●	●	●
●	●	●	●
●	●	●	●
●	●	●	●
●	●	●	●
●	●	●	●
●	●	●	●
●	●	●	●
●	●	●	●
●	●	●	●
●	●	●	●
●	●	●	●
●	●	●	●
●	●	●	●
●	●	●	●
●	●	●	●

ROUGH-IN SPECIFICATIONS

DIMENSIONS

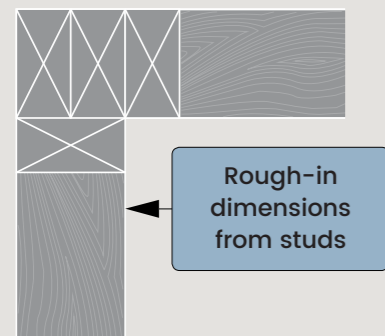

Rough-in
dimensions
from studs

WALL DETAIL

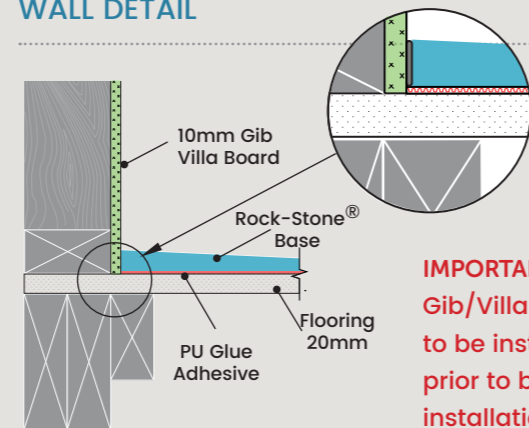

IMPORTANT
Gib/Villa Board
to be installed
prior to base
installation

TILE & SLATE FLOOR DETAIL – THRESHOLD

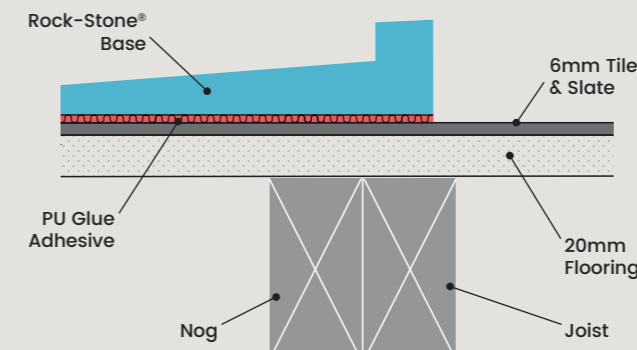

CONCRETE FLOOR DETAIL – THRESHOLD

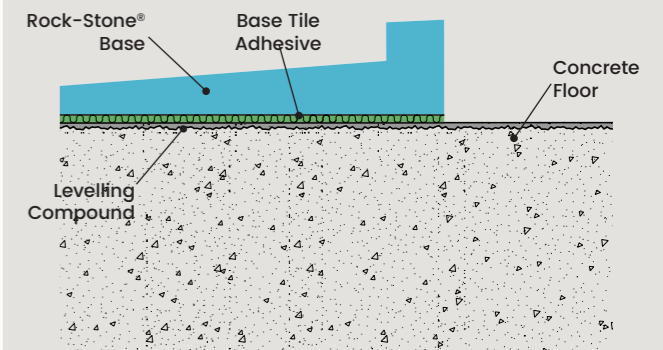

solaire® Base Installation

Level Entry Bases

Oben makes it Easy!



1 Mark outline of base on timber floor

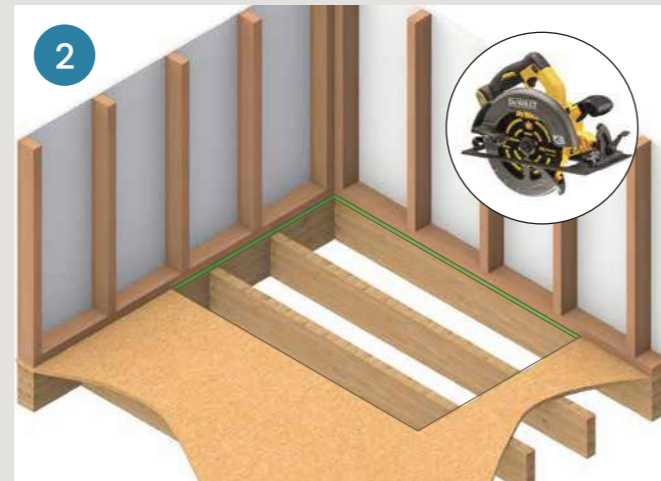

2 Cut out 20mm flooring and remove

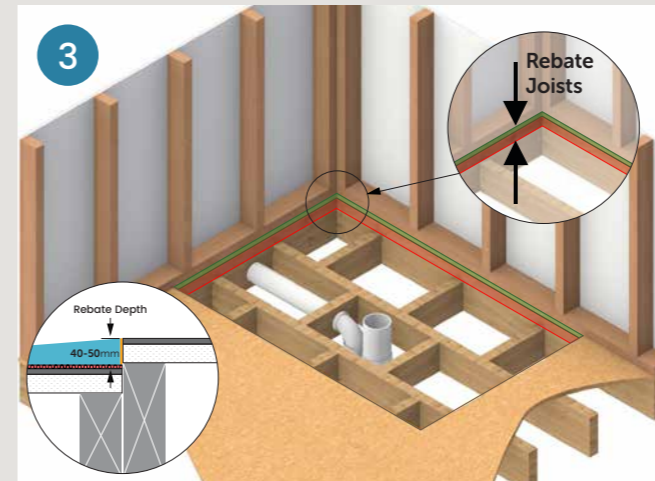

3 Rebate joists to required depth to suit base model
Fix additional joists to support ply infill

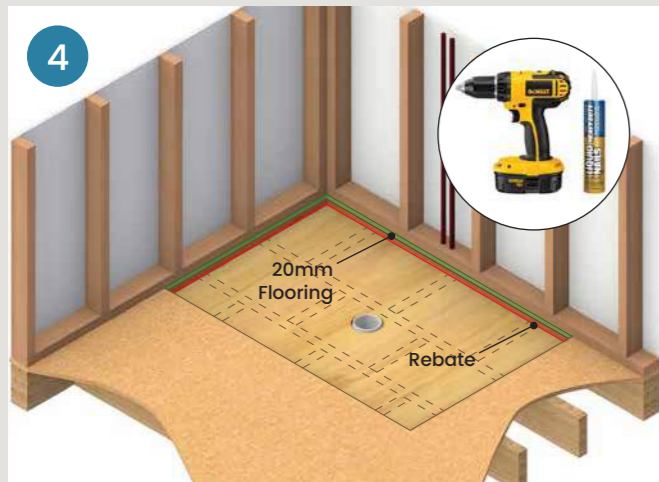

4 Install 20mm marine ply or compressed sheet.
Glue and screw into position

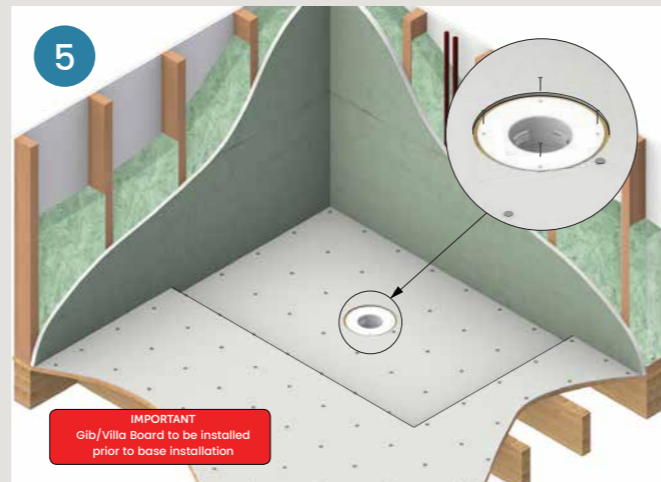

5 Glue PVC Flange to drain. Install tile & slate, ensuring
6mm clearance around LM flange. Install Gib/Villa
board walls



6a **Tile & Slate Floor** - Apply polyurethane adhesive.
2hr cure time (adhesive kit included)

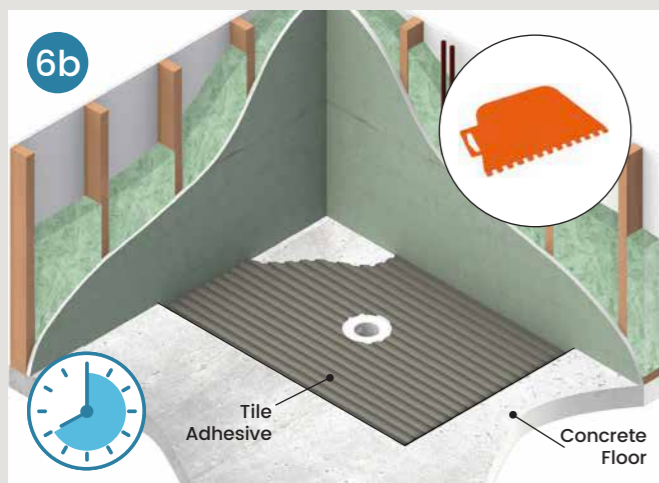

6b **Concrete Floor** - Mix tile adhesive and apply with
trowel into rebated base area. 8 hour cure time
(adhesive kit included)

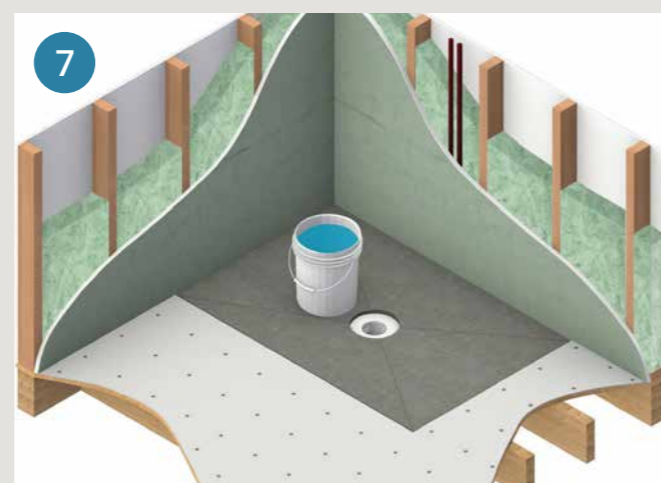

7 **Fit Solaire®** base and weigh down with adhesive pallet
filled with water

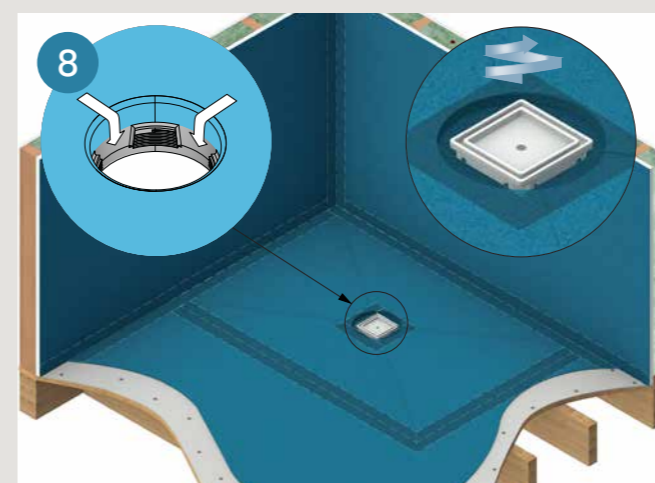

8 Apply butyl tapes and waterproof floors and walls.
Screw the centre drain tile insert component into the
LM flange

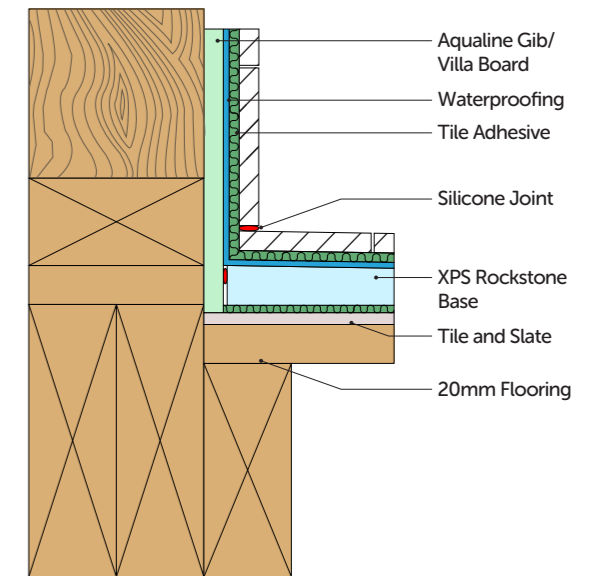

Rebate joists to required depth to suit base model
Fix additional joists to support ply infill

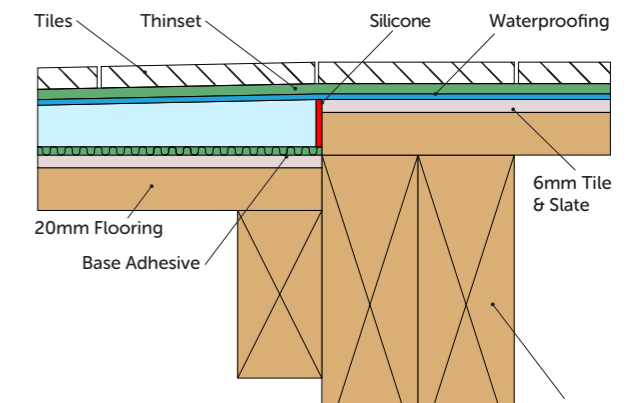

Rebate joists to required depth to suit base model
Fix additional joists to support ply infill

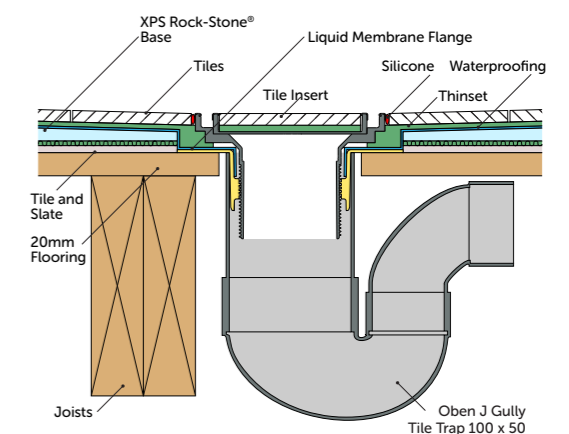

Rebate joists to required depth to suit base model
Fix additional joists to support ply infill

Apply butyl tapes and waterproof floor and walls as shown

solaire® Level Entry – Corner Technical

ROCK-STONE® BASE AVAILABILITY ● Ex Stock ● Made To Order (5 working days) ● Glass Availability

CORNER – CENTRE OUTLET

Corner Square

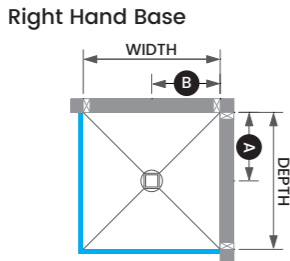
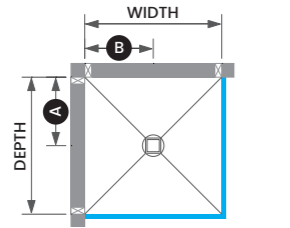
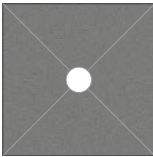

Size	Rock-Stone® Base		Drain Outlet		Base Height	Recess Depth	Availability
	Depth	Width	A	B			
800 X 800	790	790	400	400	36	40	●
850 X 850	840	840	425	425	36	40	●
900 X 900	890	890	450	450	36	40	●
950 X 950	940	940	475	475	36	40	●
1000 X 1000	990	990	500	500	36	40	●
1050 X 1050	1040	1040	525	525	36	40	●
1100 X 1100	1090	1090	550	550	36	40	●
1200 X 1200	1190	1190	600	600	36	40	●



Corner Rectangle

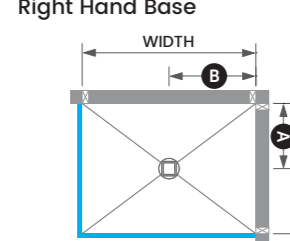
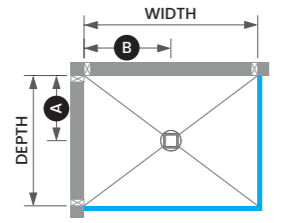
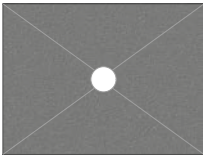

900 X 1000	890	990	450	500	36	40	●
900 X 1100	890	1090	450	550	36	40	●
900 X 1200	890	1190	450	600	36	40	●
900 X 1300	890	1290	450	650	36	40	●
900 X 1400	890	1390	450	700	36	40	●
900 X 1500	890	1490	450	750	36	40	●
900 X 1600	890	1590	450	800	36	50	●
900 X 1700	890	1690	450	850	36	50	●
900 X 1800	890	1790	450	900	36	50	●
900 X 1900	890	1890	450	950	46	50	●
900 X 2000	890	1990	450	1000	46	50	●
1000 X 1100	990	1090	500	550	36	40	●
1000 X 1200	990	1190	500	600	36	40	●
1000 X 1300	990	1290	500	650	36	40	●
1000 X 1400	990	1390	500	700	36	40	●
1000 X 1500	990	1490	500	750	36	40	●
1000 X 1600	990	1590	500	800	36	40	●
1000 X 1700	990	1690	500	850	36	40	●
1000 X 1800	990	1790	500	900	36	40	●
1000 X 1900	990	1890	500	950	46	50	●
1000 X 2000	990	1990	500	1000	46	50	●

Corner Neo-Angle

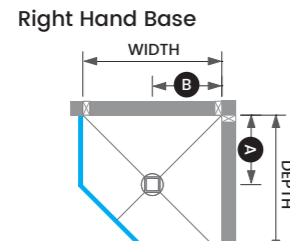
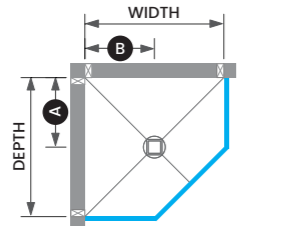
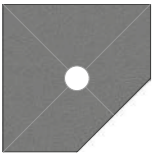

Size	Rock-Stone® Base		Drain Outlet		Base Height	Recess Depth	Availability
	Depth	Width	A	B			
900 X 900	890	890	450	450	36	40	●
950 X 950	940	940	475	475	36	40	●
1000 X 1000	990	990	500	500	36	40	●
1100 X 1100	1090	1090	550	550	36	40	●

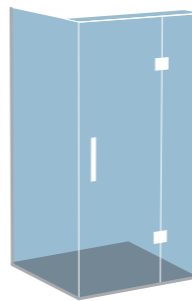

RH Hinge shown

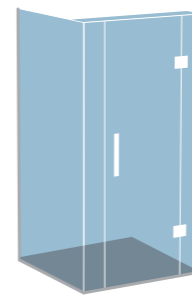

RH Hinge shown

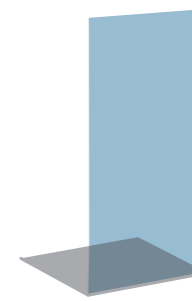

LH Door shown

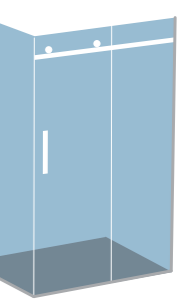
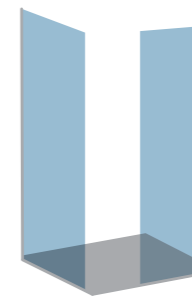

LH Door shown

DOOR OFFSET (Reversible)	DOOR CENTRE (Reversible)	FIXED PANEL (Reversible)	WALK-IN (Reversible)	2-P SLIDING (Reversible)
●	●	●		
●	●	●		
●	●	●		●
●	●	●		●
●	●	●		●
●	●	●		●
●	●	●		●
●	●	●	●	●
●	●	●	●	●
●	●	●	●	●
●	●	●	●	●
●	●	●	●	●
●	●	●	●	●
●	●	●	●	●
●	●	●	●	●
●	●	●	●	●
●	●	●	●	●
●	●	●	●	●
●	●	●	●	●

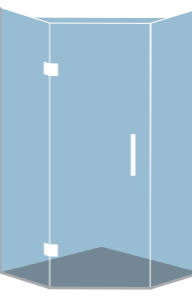

LH Hinge shown

DOOR OFFSET (Reversible)
●
●
●
●

solaire® Level Entry - Alcove Technical

ROCK-STONE® BASE AVAILABILITY

● Ex Stock ● Made To Order (5 working days) ● Glass Availability

ALCOVE - CENTRE OUTLET

Alcove Square

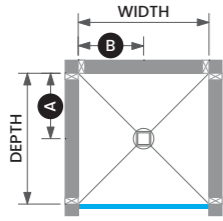
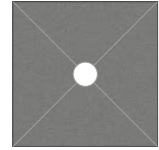

Size	Rock-Stone® Base		Drain Outlet		Base Height	Recess Depth	Availability
	Depth	Width	A	B			
800 X 800	790	780	400	400	36	40	●
850 X 850	840	830	425	425	36	40	●
900 X 900	890	880	450	450	36	40	●
950 X 950	940	930	475	475	36	40	●
1000 X 1000	990	980	500	500	36	40	●
1050 X 1050	1040	1030	525	525	36	40	●
1100 X 1100	1090	1080	550	550	36	40	●
1200 X 1200	1190	1180	600	600	36	40	●

Alcove Rectangle

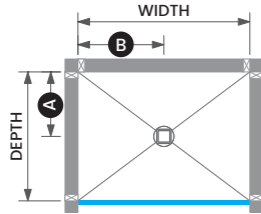
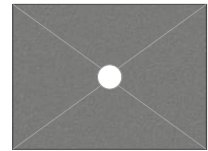

900 X 1000	890	980	450	500	36	40	●
900 X 1100	890	1080	450	550	36	40	●
900 X 1200	890	1180	450	600	36	40	●
900 X 1300	890	1280	450	650	36	40	●
900 X 1400	890	1380	450	700	36	40	●
900 X 1500	890	1480	450	750	36	40	●
900 X 1600	890	1580	450	800	36	50	●
900 X 1700	890	1680	450	850	36	50	●
900 X 1800	890	1780	450	900	36	50	●
900 X 1900	890	1880	450	950	46	50	●
900 X 2000	890	1990	450	1000	46	50	●

1000 X 1100	990	1080	500	550	36	40	●
1000 X 1200	990	1180	500	600	36	40	●
1000 X 1300	990	1280	500	650	36	40	●
1000 X 1400	990	1380	500	700	36	40	●
1000 X 1500	990	1480	500	750	36	40	●
1000 X 1600	990	1580	500	800	36	50	●
1000 X 1700	990	1680	500	850	36	50	●
1000 X 1800	990	1780	500	900	36	50	●
1000 X 1900	990	1880	500	950	46	50	●
1000 X 2000	990	1980	500	1000	46	50	●

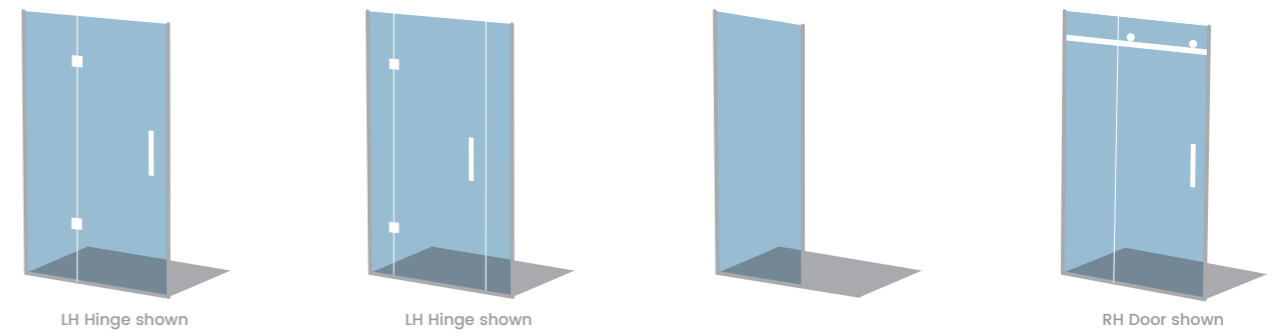

DOOR OFFSET (Reversible)	DOOR CENTRE (Reversible)	FIXED PANEL (Reversible)	2-P SLIDING (Reversible)
●	●		
●	●		
●	●		
●	●		
●	●		
●	●		
●	●		
●	●		

●	●		●
●	●		●
●	●		●
●	●	●	●
●	●	●	●
●	●	●	●
●	●	●	●
●	●	●	●
●	●	●	●
●	●	●	●
●	●	●	●
●	●	●	●
●	●	●	●
●	●	●	●
●	●	●	●
●	●	●	●
●	●	●	●
●	●	●	●
●	●	●	●
●	●	●	●
●	●	●	●

ROUGH-IN SPECIFICATIONS

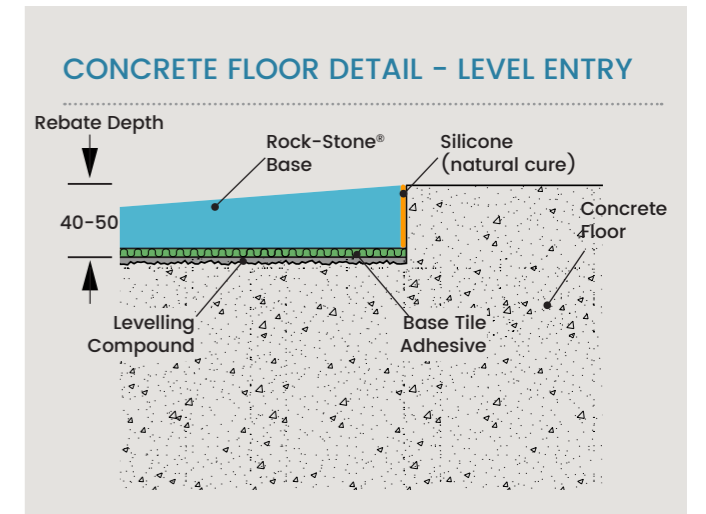
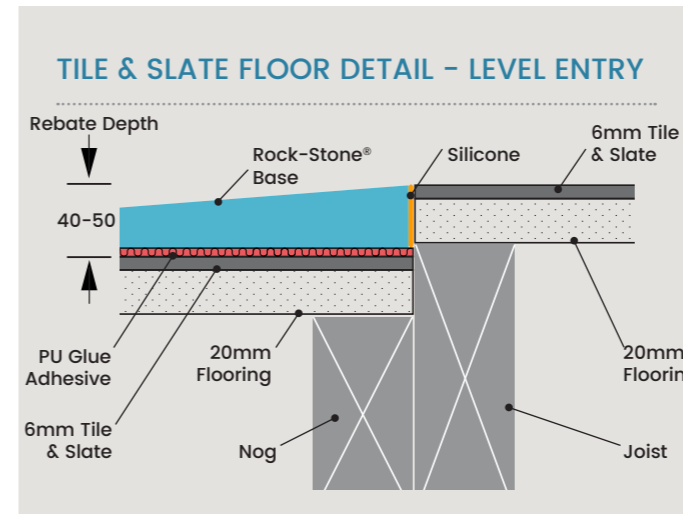
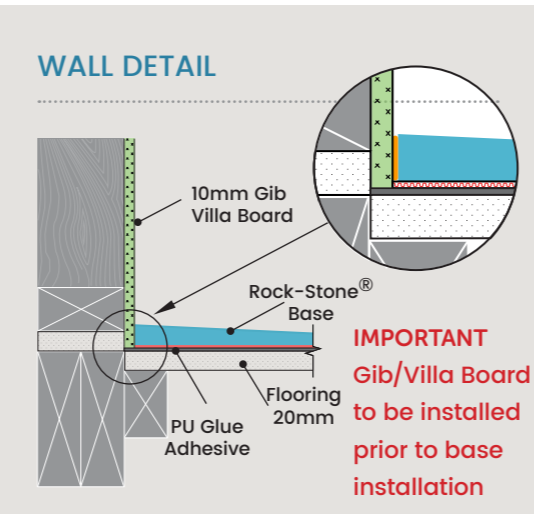
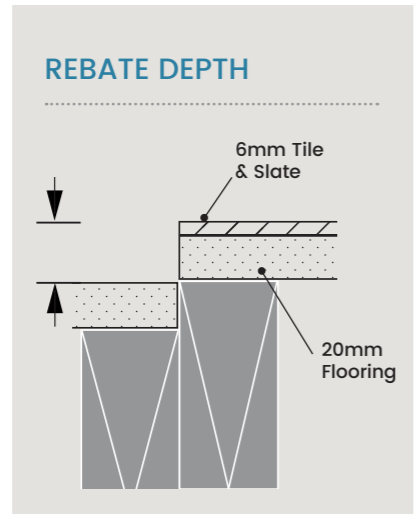
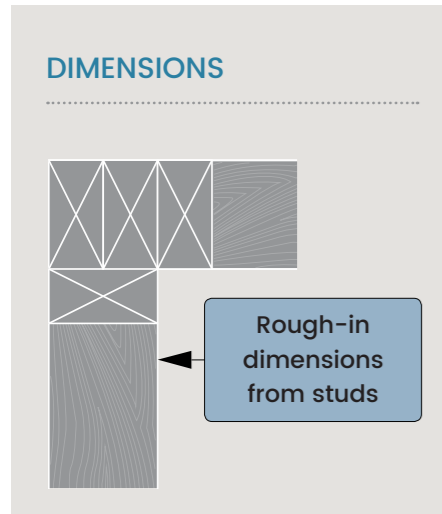

SHOWER MIXER POSITION?

With today's Walk-In showers becoming larger and more popular than ever it is important that the mixer position be considered so the bather can adjust temperature during showering.

After the first minute of showering the body's skin receptors become acclimatised to original temperature set and requires an incremental stepped increase of 1°C every minute over a two-minute period to eliminate any body cooling effect.

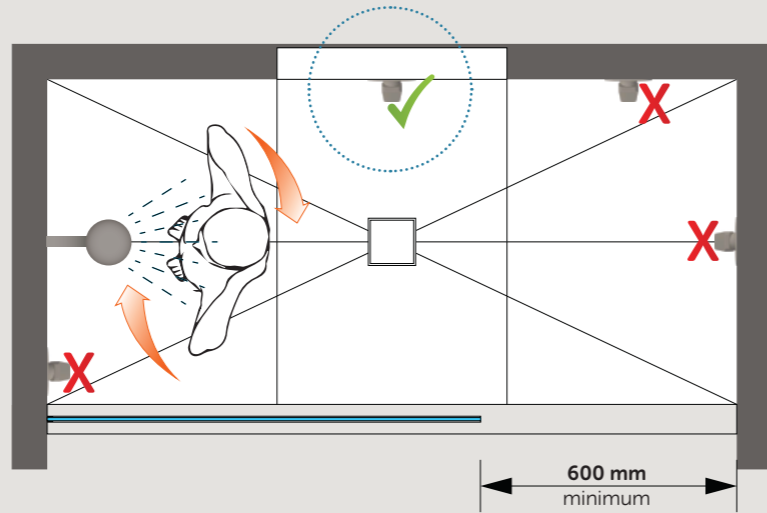

The shower mixer should be positioned where the bather can easily reach the mixer to adjust water temperature during showering.

SHOWER MIXER HEIGHT?

If specifying a recessed shower niche, then you will need to ensure your plumber installs the shower mixer to the recommended height of 1000 mm off the sub floor allowing sufficient clearance between mixer elbow and niche nog support.

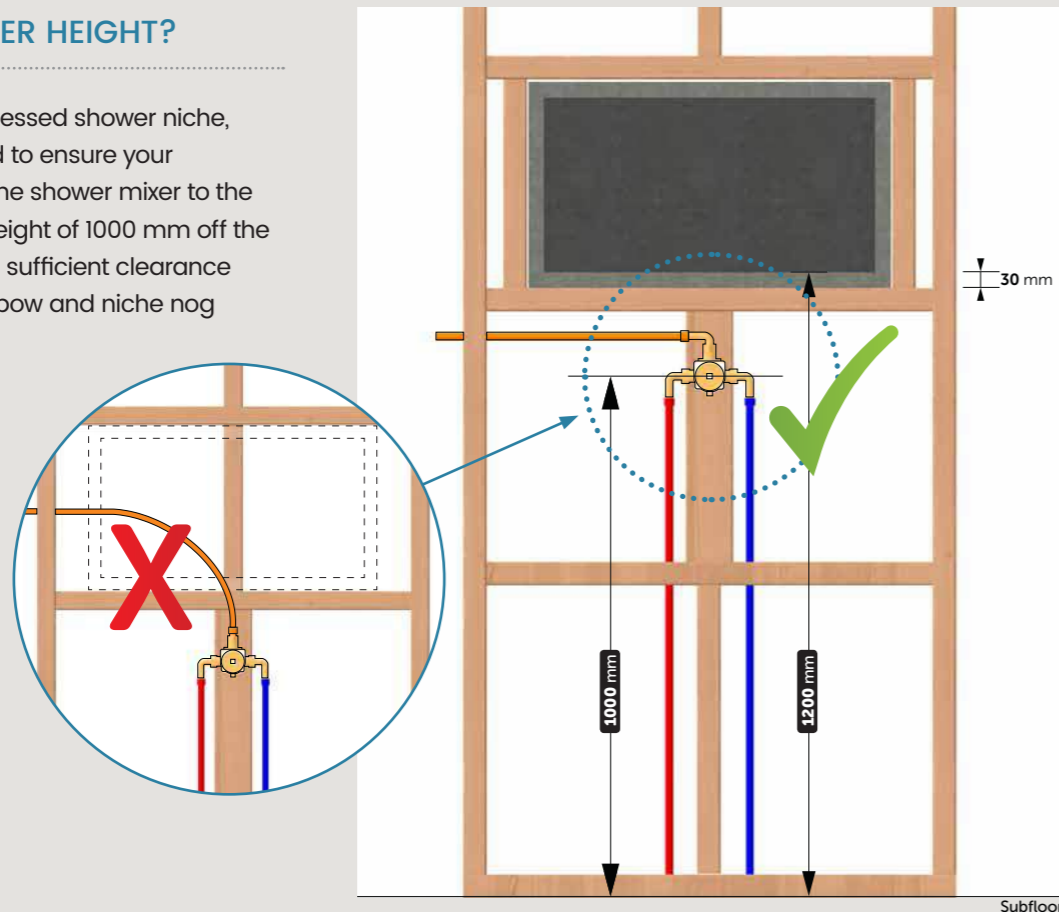

SHOWER NICHE HEIGHT?

Oben recommends internal niche shelf height is set at 1200 mm off sub floor and allows for a 20 mm safety buffer which can be used to raise the niche shelf tile height junction to match the finished wall tile height.

Ask your builder to consult with your tiler regarding your actual shower recess height required as this may vary depending on actual tile size selection, grout joints and tiled floor levels.

Tile are a nominal size and can vary from actual size advertised. (Example a generic 600 X 600 tile may in fact be only 590 X 590)

IMPORTANT

Tile layout dimensions and drawings provided are to be used as a "Guide Only" and actual height must be specified by a tiler in conjunction with your builder in order to determine niche height required to suit your wall tile selection.

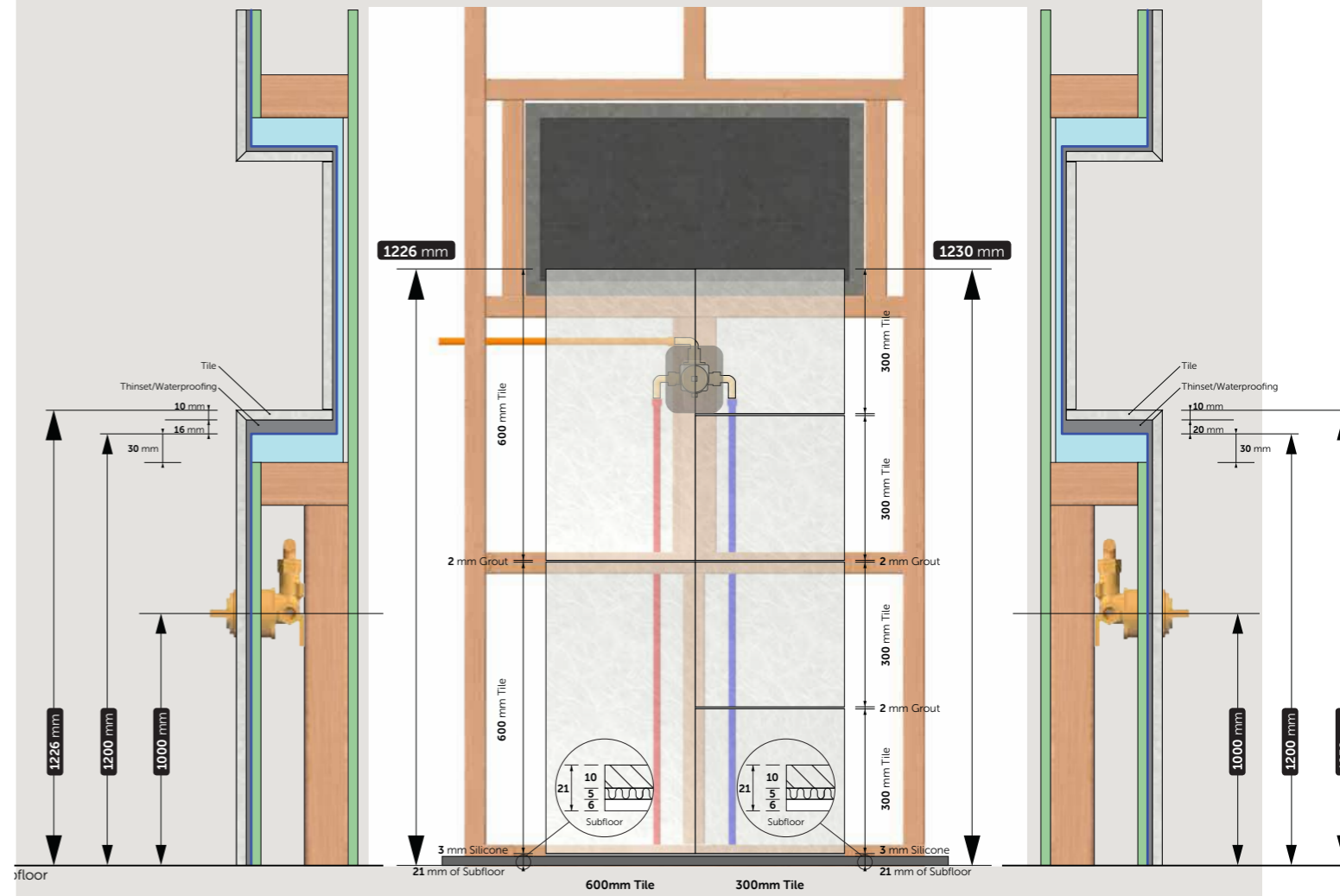

MORE OBEN BROCHURES

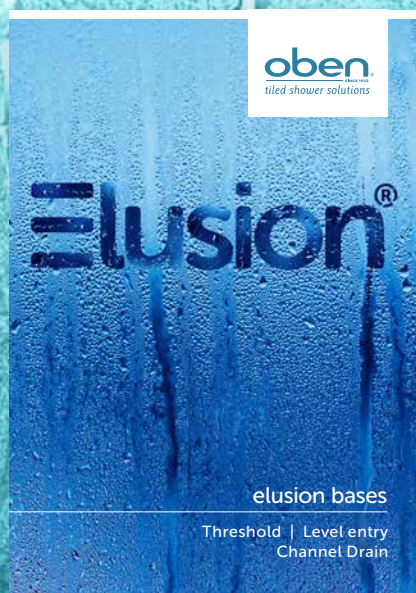
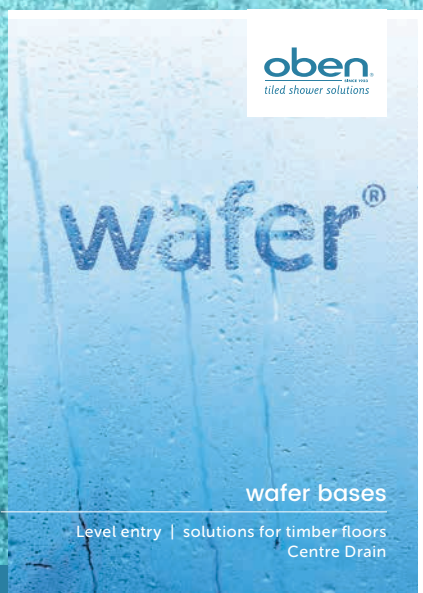

Oben
10.B Parity Place
Hillcrest
Auckland 0627
T 09 44 33 879
E sales@oben.co.nz
W www.oben.co.nz

Oben reserves all rights to alter designs and specification without notice. All dimensions given are approximate and should be checked prior to installation. Products shown in Catalogues, Order Forms and digital format are subject to Intellectual Property Protection. NZ and International Patents Pending. ® Registered Trademarks of Oben. Oben's continuous product improvement policy means some product enhancements may not be available at time of order placement due to current stock and phasing in/out of new models.

Quotations valid 30 days from date of quote. Prices subject to re quote after expiry of 30 days. Prices quoted are subject to final site measure. (Contact Oben Customer Service for further details.) Tapware & Accessories featured in photography are not included.

oben[®]
SINCE 1923
tiled shower solutions

•Design •Quality •Service

All products available Ex Oben warehouse Auckland and do not include shipping & handling costs which will be charged separately on invoices. Custom made to order products are Non-Refundable.

© Oben solaire® Brochure April 2019